

# 1604VLZ4, 1604-VLZ3, 1604-VLZ PRO and 1604VLZ RotoPod Installation

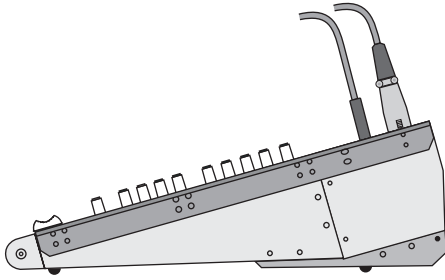

The RotoPod is a bracket/rack combination that enables the 1604VLZ4, 1604-VLZ3, 1604-VLZ PRO or 1604VLZ to be rotated onto the same plane as the main controls; in other words, face up. By installing the RotoPod, you are converting the mixer from a 10-rackspace mixer with rear-facing jacks to a 10W-rackspace configuration with front-facing jacks. This leaves room to pass cables and connectors through in rack-mount applications. This setup is also great for tabletop applications when you want instant, in-your-face access to inputs and outputs.

## Parts

### RotoPod Kit Contents – Part No. 090-050-90:

- 1 RotoPod Bracket – Part No. 550-178-00
- 1 RotoPod Rack Rail (marked “L”) – Part No. 550-179-00
- 1 RotoPod Rack Rail (marked “R”) – Part No. 550-180-00
- 4 #8-32 x 1/4 Black Screws – Part No. 700-004-00
- 6 M3.5 x 0.6 x 6 mm Silver Screws – Part No. 0020991-06
- 2 Rubber Feet – Part No. 750-001-00
- 1 Installation Instruction Sheet – Part No. 820-036-00

## Tools

### Required Tools (not included):

Phillips screwdriver

## RotoPod Installation

1. Turn off the mixer and disconnect the power cable.
2. Flip the mixer over onto a soft, dry surface. Using the Phillips screwdriver, remove the four screws from the ribbon cable plate, as shown below. Be sure to store the ribbon cable plate somewhere safe, as you may decide to use it again one day.

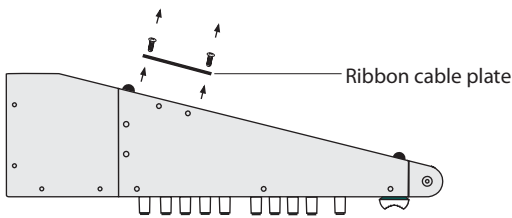

3. Remove the four biggest screws from the mixer, two from each side. Be careful not to pull the pod too far away from the mixer, as the cables are still attached!

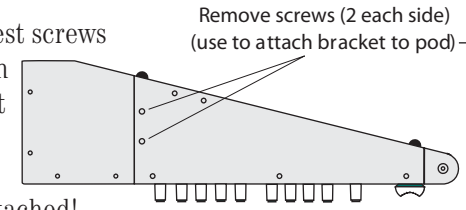

4. Now turn the mixer back over so you're looking at the top again. Rotate the pod 90° so the jacks are facing up, as well.

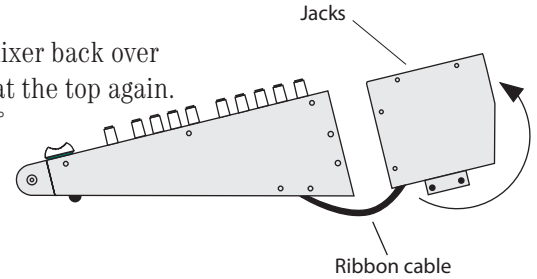

5. Set the mixer and pod onto the RotoPod Bracket so that the tabs of the Rotopod fit into the slots on the bottoms of both the mixer and the pod.

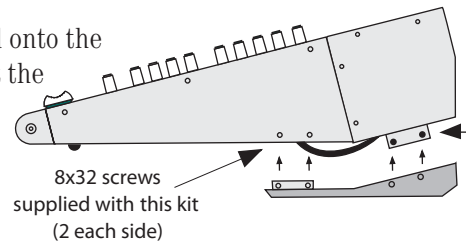

6. Put the four #8-32 black screws into the bottom of the RotoPod Bracket and tighten them up.

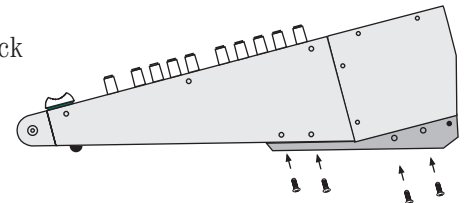

7. Take off the short rack rails (if previously installed) and replace them with the new, long rack rails. [“L” on the left side of the mixer and “R” on the right side of the mixer].

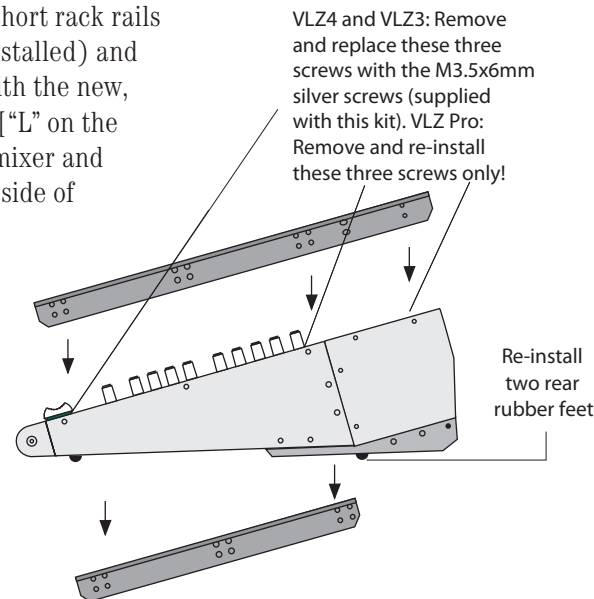

 Like us

 Follow us

 Watch our dang videos



16220 Wood-Red Road NE • Woodinville • WA • 98072 • USA  
 Phone: 425.487.4333 • Toll-free: 800.898.3211  
 Fax: 425.487.4337 • www.720trees.com  
 ©2013 LOUD Technologies Inc. All rights reserved.  
 Part No. 820-036-00 Rev. E 07/13