

## C200

Featuring legendary Mackie sound quality and durability, the lightweight C Series 2-way Precision Passive loudspeakers deliver optimum performance in portable PA, stage monitor and permanent installation applications. The C200 is a full-range portable loudspeaker providing high-output, ultra-wide dispersion and low-distortion performance in a compact, composite molded enclosure.

A heat-treated titanium compression driver directs pristine highs through an exponential high-frequency waveguide, allowing for ultra-wide dispersion of highs and mids. This allows the C200 to deliver clear, smooth sound to audience members up to 45° off axis.

The custom-designed high-power 10-inch woofer with a 2-inch voice coil allows the driver to run cooler, delivering consistent performance even after long hours of use at near peak volumes.

The crossover in the C200 is a unique Low Impedance Compensated Crossover (LICC) design with an asymmetrical slope. With EQ and crossover points meticulously chosen so that beamwidth patterns match in both drivers, C200 loudspeakers offer natural sound at all volume levels.

The center of gravity, handle locations, handle design, position of fly-points and ease of use have been ergonomically designed. There is also an integrated pole mount on the bottom of the cabinet and a weather-resistant steel grille. The asymmetrical trapezoidal cabinet has been designed to provide an ideal floor monitoring position.

The cabinet is constructed of high-pressure injected polypropylene. The enclosure features reinforcement ribbing and structural strengthening resulting in a strong, super-rigid design providing ideal acoustical characteristics.

## APPLICATIONS

Small club/band PA systems, houses of worship, DJs, vocal/band monitor wedges, gymnasiums, banquet halls, conference rooms and many, many more.



## FEATURES:

- 2-way portable Precision Passive loudspeaker system
- 500W peak / 200W RMS power handling at 8  $\Omega$
- 10" long-throw low-frequency transducer with 2" voice coil
- High-output 1.4" titanium compression driver
- Ultra-wide, smooth dispersion via HF horn design
- Integrated Low Impedance Compensated Crossover (LICC) with full driver protection
- Lightweight for ultimate portability (26 lb / 11.8 kg)
- Asymmetrical trapezoidal cabinet for floor monitor positioning
- Stand / Pole-mountable
- Flyable via optional hanging bracket kit

## C200 SPECIFICATIONS

### Acoustic Performance

Frequency Response (-3 dB)	89 Hz-20 kHz
Frequency Range (-10 dB)	59 Hz-22 kHz
Max SPL long-term	118 dB @ 1 m
Low-Frequency Crossover Type	6 dB / octave, time offset corrected
High-Frequency Crossover Type	12 dB / octave
Crossover Point	1800 Hz

### Audio

Input / Thru Connector Type	Speakon™-style NL-4 jack 1/4" TS jack
Input Impedance	8 Ω
Power Handling	
RMS	200 watts
Music	350 watts
Peak	500 watts
Operating Temperature Range	-10° C to 45° C 14° F to 113° F

### Low-Frequency Transducer

Diameter	10 in / 250 mm
Voice Coil Diameter	2 in / 51 mm
Magnet Material	Ferrite

### High-Frequency Transducer

Diaphragm Diameter	1.4 in / 36 mm
Diaphragm Material	Heat treated titanium
Horn Exit Diameter	1 in / 24.5 mm

### Horn Design

Type	Conical and Exponential
Mouth Size	12 in / 305 mm (W) x 7 in / 178 mm (H)
Horizontal Coverage	90° (1 kHz - 20 kHz)
Vertical Coverage	80° (1 kHz - 20 kHz)

### Safety Features

Driver Protection	Dynamic protection for compression driver
-------------------	---

### Construction Features

Basic Design	Asymmetrical Trapezoidal
Material	Polypropylene
Finish	Black, textured finish
Handles	One on right side, one on top
Grille	Perforated metal with weather-resistant coating

### Physical Properties (packaged product)

Height	21.5 in / 546 mm
Width	13.2 in / 335 mm
Depth	12.4 in / 315 mm
Shipping Weight	30.0 lb / 13.6 kg

### Physical Properties (product)

Height	20.8 in / 527 mm
Width	13.1 in / 333 mm
Depth	12.3 in / 311 mm
Net Weight	26.0 lb / 11.8 kg

### Mounting Methods

Floor mount, pole mount, or fly via optional bracket

### Options

SPM200 Loudspeaker Pole Mount	P/N 2035170-01
C200 Bracket Kit	P/N 0016404

### Ordering Information

C200 Passive 2-way Loudspeaker	P/N 2033791
C200 Passive 2-way Loudspeaker, CN	P/N 2033791-05

## C200 HORIZONTAL POLARS

Gridlines: 6 dB axial / 15 degrees radial

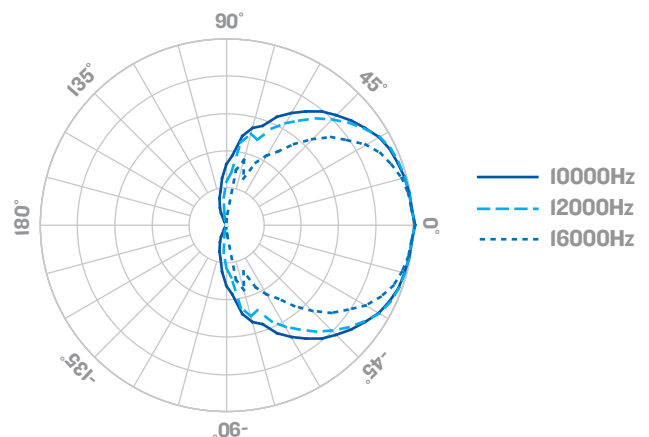
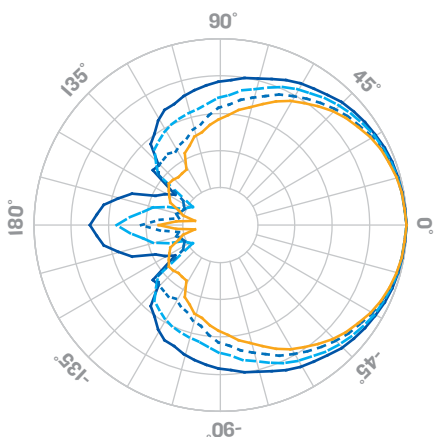
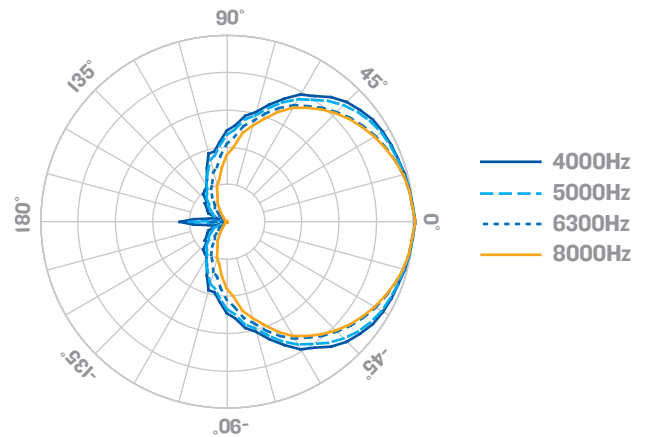
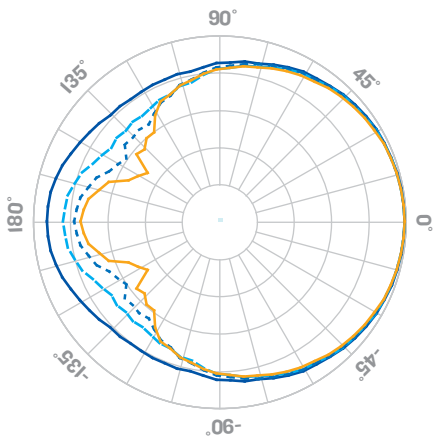
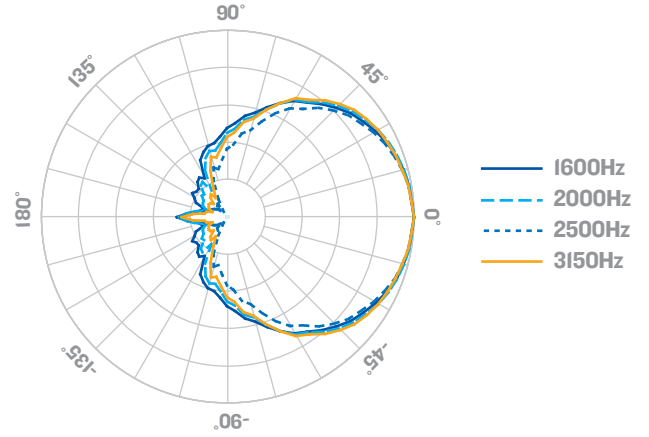
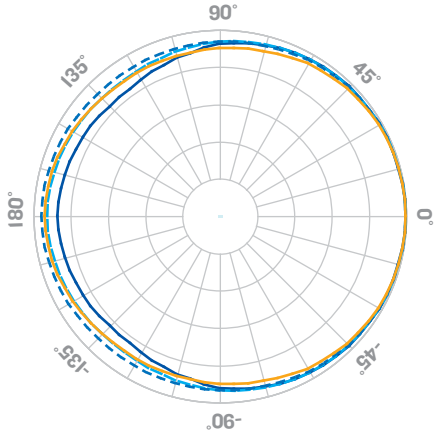

## C200 VERTICAL POLARS

Gridlines: 6 dB axial / 15 degrees radial

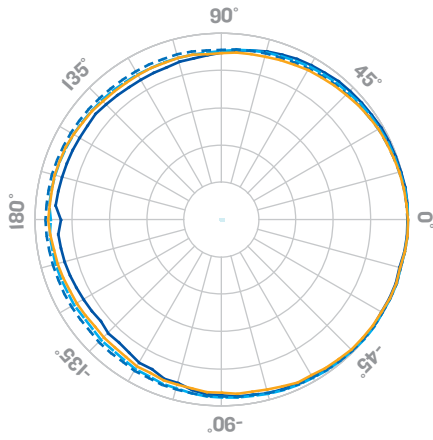

— 100Hz  
- - 125Hz  
... 160Hz  
— 200Hz

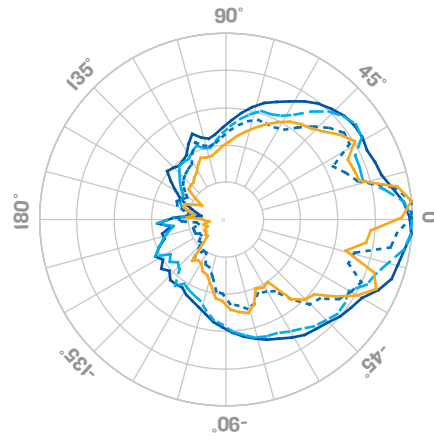

— 1600Hz  
- - 2000Hz  
... 2500Hz  
— 3150Hz

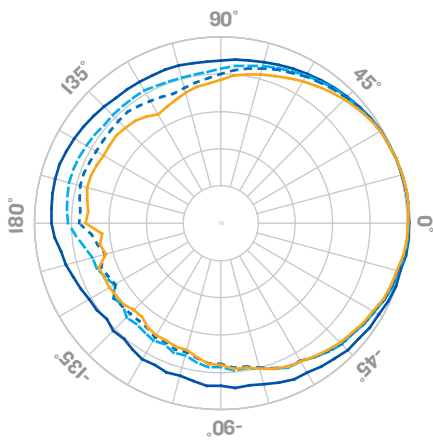

— 250Hz  
- - 315Hz  
... 400Hz  
— 500Hz

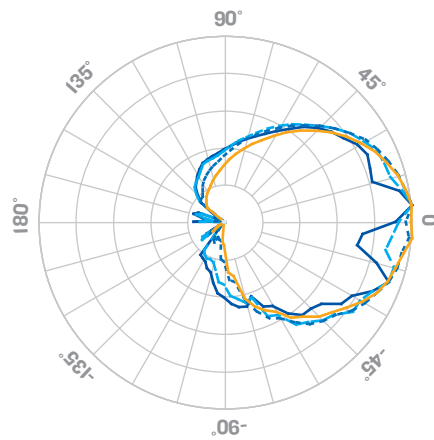

— 4000Hz  
- - 5000Hz  
... 6300Hz  
— 8000Hz

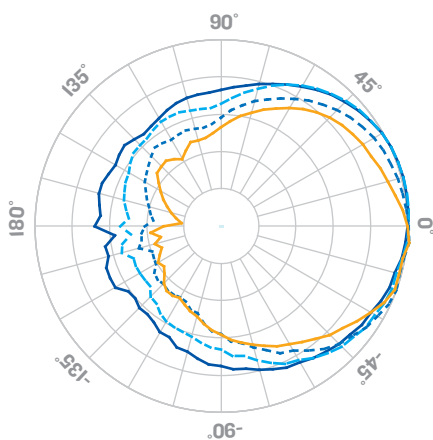

— 630Hz  
- - 800Hz  
... 1000Hz  
— 1250Hz

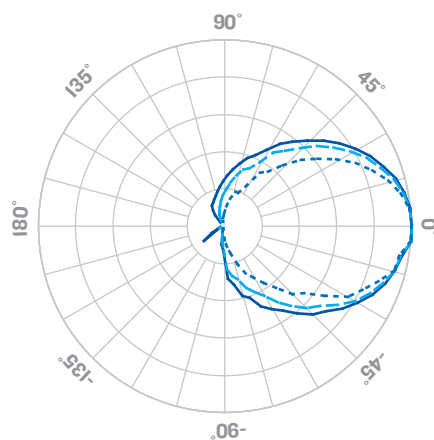

— 10000Hz  
- - 12000Hz  
... 16000Hz

## C200 FREQUENCY RESPONSE

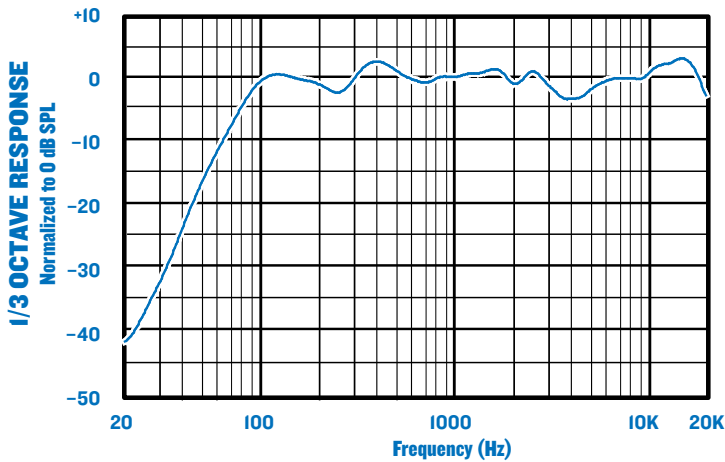

## C200 INPUT PANEL

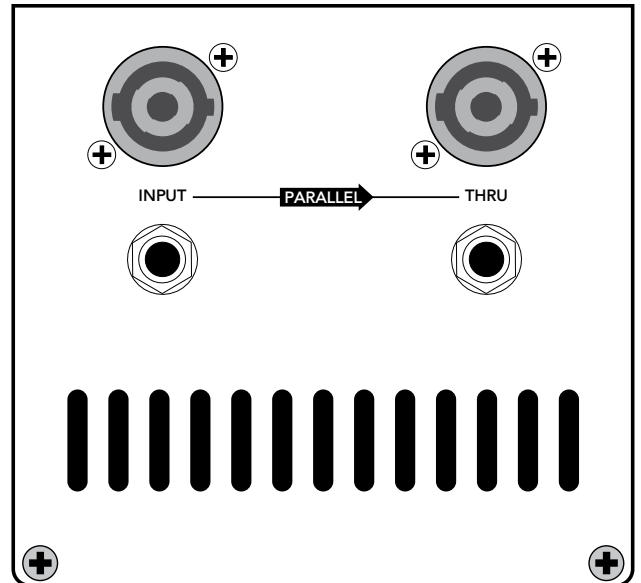

## C200 DIMENSIONS

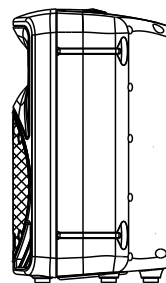
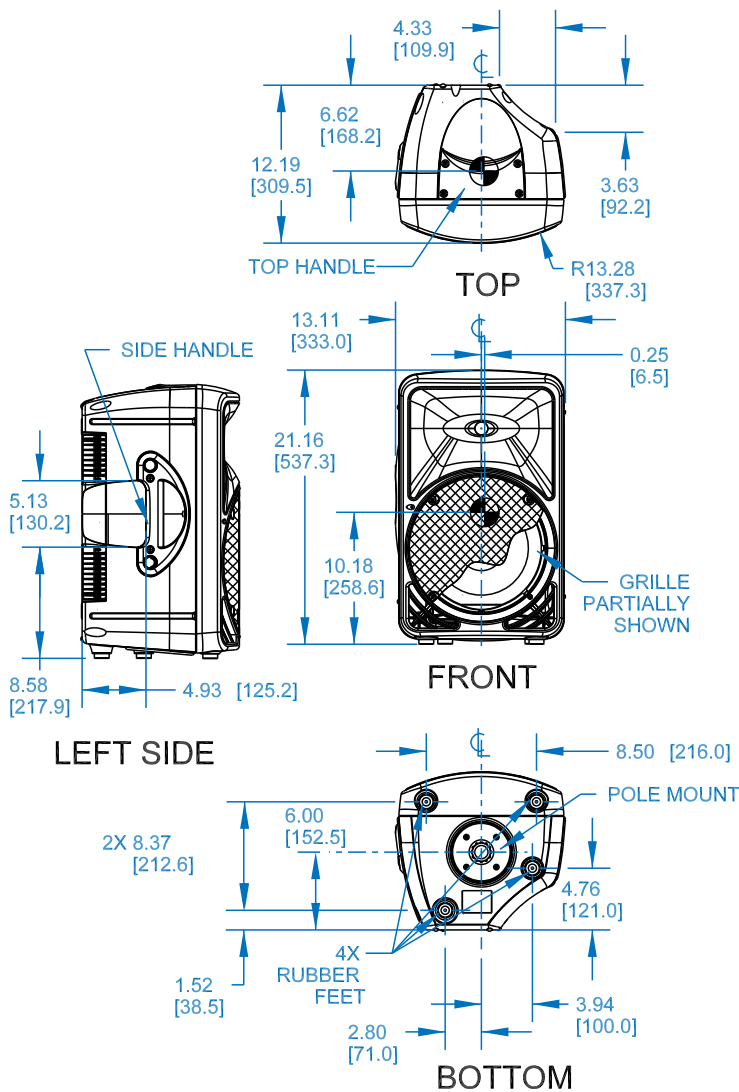

RIGHT SIDE

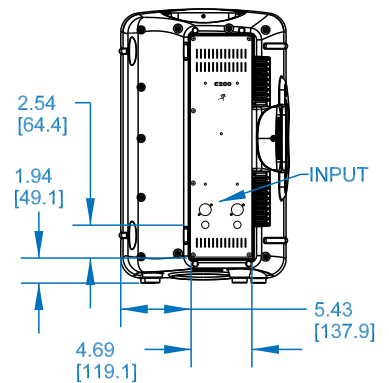

BACK

- NOTES:
1. SYMBOL INDICATES CENTER OF BALANCE.
  2. WEIGHT APPROX. 26.0 lb [11.8 kg].
  3. SHIPPING WEIGHT APPROX. 30.0 lb [13.6 kg].

UNLESS OTHERWISE SPECIFIED: ALL DIMENSIONS ARE IN INCHES. DUAL [MM] DIMENSIONS FOR REF ONLY

TOLERANCES  
 LINEAR  $\pm 0.13$  in./  $\pm 3.3$ mm; ANGLES  $\pm 1^\circ$   
 (X.XX) = REF DIMS  
 NO TOLERANCE IMPLIED

TSC=THEORETICAL SHARP CORNER  
 DIMENSIONS ACROSS CENTERLINES  
 TO BE SYMMETRICAL

## C200 FLY POINTS

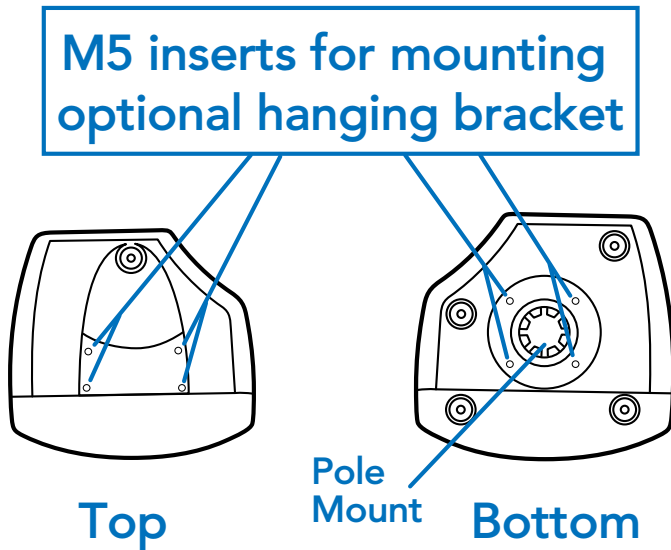

Electronic files for this product are available at:

[www.mackie.com](http://www.mackie.com)

Specification Sheet

C200\_SS.PDF

Owner's Manual

C200\_OM.PDF

# MACKIE®

[www.mackie.com](http://www.mackie.com)

16220 Wood-Red Road NE

Woodinville, WA 98072 USA

800-898-3211, Fax 425-487-4337, [sales@mackie.com](mailto:sales@mackie.com)

Part No. SW0767 Rev. B 06/10

Since we are always striving to make our products better by incorporating new and improved materials, components, and manufacturing methods, we reserve the right to change these specifications at any time without notice. "Mackie" and the "Running Man" figure are registered trademarks of LOUD Technologies Inc. All other brand names mentioned are trademarks or registered trademarks of their respective holders, and are hereby acknowledged.

©2010 LOUD Technologies Inc. All Rights Reserved.