

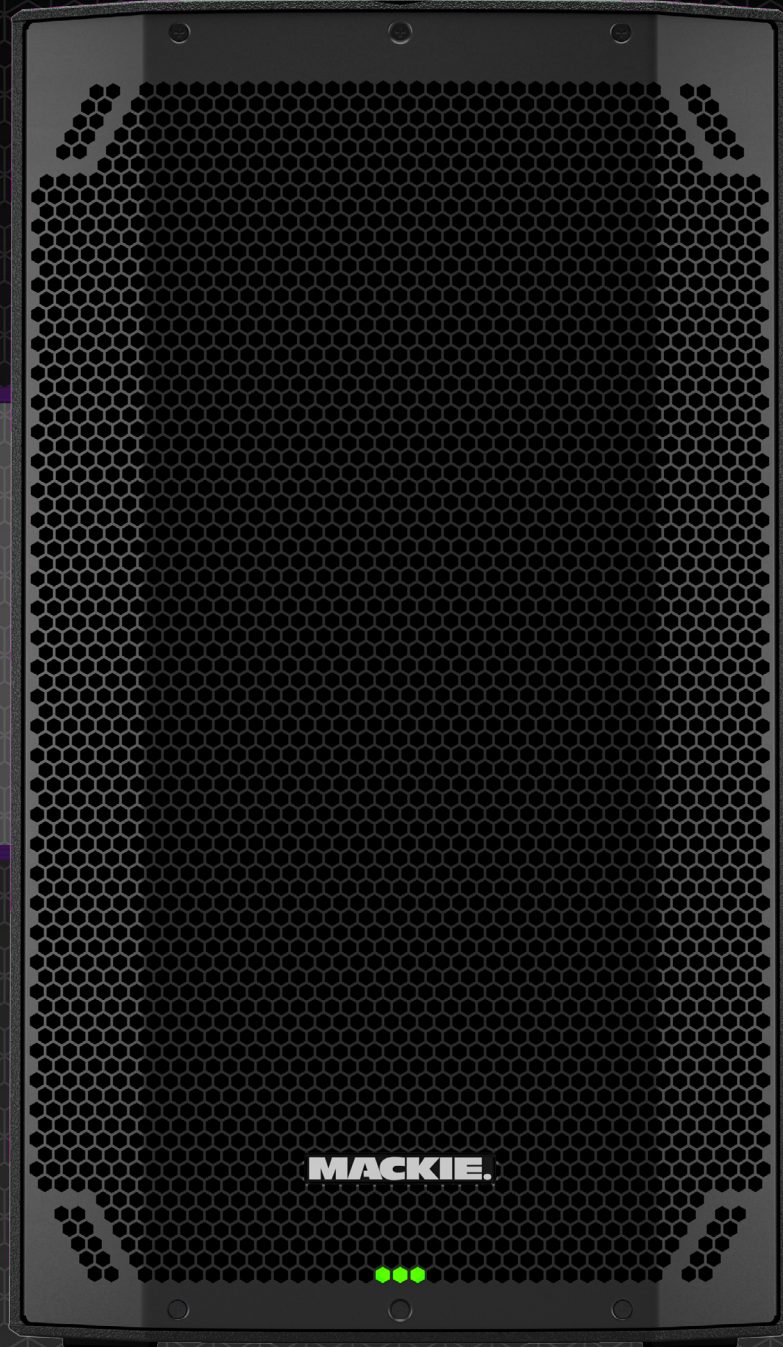

# THUMP v4

PROFESSIONAL POWERED LOUDSPEAKER SERIES

## OWNER'S MANUAL





**MACKIE.**

# Important Safety Instructions

1. Read these instructions.
2. Keep these instructions.
3. Heed all warnings.
4. Follow all instructions.
5. Do not use this apparatus near water.
6. Clean only with a dry cloth.
7. Do not block any ventilation openings. Install in accordance with the manufacturer's instructions.
8. Do not install near any heat sources such as radiators, heat registers, stoves, or other apparatus (including amplifiers) that produce heat.
9. Protect the power cord from being walked on or pinched particularly at plugs, convenience receptacles, and the point where they exit from the apparatus.
10. Only use attachments/accessories specified by the manufacturer.
11. Use only with a cart, stand, tripod, bracket, or table specified by the manufacturer, or sold with the apparatus. When a cart is used, use caution when moving the cart/apparatus combination to avoid injury from tip-over.
12. Unplug this apparatus during lightning storms or when unused for long periods of time.
13. Refer all servicing to qualified service personnel. Servicing is required when the apparatus has been damaged in any way, such as power-supply cord or plug is damaged, liquid has been spilled or objects have fallen into the apparatus, the apparatus has been exposed to rain or moisture, does not operate normally, or has been dropped.
14. This apparatus shall not be exposed to dripping or splashing, and no object filled with liquids, such as vases or beer glasses, shall be placed on the apparatus.
15. Do not overload wall outlets and extension cords as this can result in a risk of fire or electric shock.





17.  This apparatus has been designed with Class-I construction and must be connected to a mains socket outlet with a protective earthing connection (the third grounding prong).
18. The MAINS plug or an appliance coupler is used as the disconnect device, so the disconnect device shall remain readily operable.
19. The equipment complies with FCC/IC RSS-102 radiation exposure limits set forth for an uncontrolled environment. The equipment should be installed and operated with minimum distance 20cm between the radiator & your body.  
*Cet appareil est conforme aux limites d'exposition aux radiations de la FCC/IC RSS-102 énoncées pour un environnement non contrôlé. Il doit être installé et utilisé avec une distance minimale de 20 cm entre le radiateur et votre corps.*
20. The use of apparatus is in tropical and/or moderate climates.
21. The maximum ambient temperature during use of the appliance must not exceed 0-45° C // 32-113° F.
22. Operation frequency: 2402MHz – 2480MHz
23. RF POWER = <4dBm
24. This apparatus does not exceed the Class A/Class B (whichever is applicable) limits for radio noise emissions from digital apparatus as set out in the radio interference regulations of the Canadian Department of Communications.  
CAN ICES-003(A)/NMB-003(A)  
**ATTENTION** — *Le présent appareil numérique n'émet pas de bruits radioélectriques dépassant les limites applicables aux appareils numériques de class A/de class B (selon le cas) prescrites dans le règlement sur le brouillage radioélectrique édicté par les ministere des communications du Canada.*
25. This device complies with Part 15 of the FCC Rules [and contains license-exempt transmitter(s)/receiver(s) that comply with Innovation, Science and Economic Development Canada's license-exempt RSS(s)]. Operation is subject to the following two conditions:  
(1) this device may not cause harmful interference, and  
(2) this device must accept any interference received, including interference that may cause undesired operation.

CAUTION

RISK OF ELECTRIC SHOCK! DO NOT OPEN!

CAUTION: TO REDUCE THE RISK OF ELECTRIC SHOCK DO NOT REMOVE COVER (OR BACK). NO USER-SERVICEABLE PARTS INSIDE. REFER SERVICING TO QUALIFIED PERSONNEL.

 The lightning flash with arrowhead symbol within an equilateral triangle is intended to alert the user to the presence of uninsulated "dangerous voltage" within the product's enclosure, that may be of significant magnitude to constitute a risk of electric shock to persons.

 The exclamation point within an equilateral triangle is intended to alert the user of the presence of important operating and maintaining (servicing) instructions in the literature accompanying the appliance.

16. **NOTE:** This equipment has been tested and found to comply with the limits for a Class A digital device, pursuant to part 15 of the FCC Rules. These limits are designed to provide reasonable protection against harmful interference in a residential installation. This equipment generates, uses, and can radiate radio frequency energy and, if not installed and used in accordance with the instructions, may cause harmful interference to radio communications. However, there is no guarantee that interference will not occur in a particular installation. If this equipment does cause harmful interference to radio or television reception, which can be determined by turning the equipment off and on, the user is encouraged to try to correct the interference by one or more of the following measures:
  - Reorient or relocate the receiving antenna.
  - Increase the separation between the equipment and the receiver.
  - Connect the equipment into an outlet on a circuit different from that to which the receiver is connected.
  - Consult the dealer or an experienced radio/TV technician for help.

**WARNING:** Operation of THUMP in a residential environment could cause radio interference.

**CAUTION:** Changes or modifications to this device not expressly approved by LOUD Audio, LLC could void the user's authority to operate the equipment under FCC rules.

*L'émetteur/récepteur exempt de licence contenu dans le présent appareil est conforme aux CNR d'Innovation, Sciences et Développement économique Canada applicables aux appareils radio exempts de licence. L'exploitation est autorisée aux deux conditions suivantes:*  
(1) l'appareil ne doit pas produire de brouillage, et  
(2) l'appareil doit accepter tout brouillage radioélectrique subi, même si le brouillage est susceptible d'en compromettre le fonctionnement.

26. Exposure to extremely high noise levels may cause permanent hearing loss. Individuals vary considerably in susceptibility to noise-induced hearing loss, but nearly everyone will lose some hearing if exposed to sufficiently intense noise for a period of time. The U.S. Government's Occupational Safety and Health Administration (OSHA) has specified the permissible noise level exposures shown in the following chart.

According to OSHA, any exposure in excess of these permissible limits could result in some hearing loss. To ensure against potentially dangerous exposure to high sound pressure levels, it is recommended that all persons exposed to equipment capable of producing high sound pressure levels use hearing protectors while the equipment is in operation. Ear plugs or protectors in the ear canals or over the ears must be worn when operating the equipment in order to prevent permanent hearing loss if exposure is in excess of the limits set forth here:

Duration, per day in hours	Sound Level dBA, Slow Response	Typical Example
8	90	Duo in small club
6	92	
4	95	Subway Train
3	97	
2	100	Very loud classical music
1.5	102	
1	105	The dogs barking at the mailman
0.5	110	
0.25 or less	115	Loudest parts at a rock concert

**WARNING** — To reduce the risk of fire or electric shock, do not expose this apparatus to rain or moisture.

**CAUTION** — To prevent electric shock hazard, do not connect to mains power supply while grille is removed.



**Correct disposal of this product:** This symbol indicates that this product should not be disposed of with your household waste, according to the WEEE directive (2012/19/EU) and your national law. This product should be handed over to an authorized collection site for recycling waste electrical and electronic equipment (EEE). Improper handling of this type of waste could have a possible negative impact on the environment and human health due to potentially hazardous substances that are generally associated with EEE. At the same time, your cooperation in the correct disposal of this product will contribute to the effective usage of natural resources. For more information about where you can drop off your waste equipment for recycling, please contact your local city office, waste authority, or your household waste disposal service.

# Table of Contents

<b>Important Safety Instructions</b> .....	<b>2</b>
<hr/>	
<b>Table of Contents</b> .....	<b>3</b>
<hr/>	
<b>Chapter 1 : Welcome</b> .....	<b>6</b>
<hr/>	
<b>Introduction</b> .....	<b>6</b>
<b>Features</b> .....	<b>6</b>
<b>Things to Remember</b> .....	<b>6</b>
<b>About This Guide</b> .....	<b>7</b>
<b>Getting Started</b> .....	<b>7</b>
<hr/>	
<b>Chapter 2 : THUMPV4 Loudspeaker Series Rear Panel Features</b> .....	<b>8</b>
<hr/>	
<b>Thump Connect 2 App</b> .....	<b>8</b>
<b>Power Connector</b> .....	<b>8</b>
<b>Power Switch</b> .....	<b>8</b>
<b>XLR and 1/4" Combo Input Jacks</b> .....	<b>9</b>
<b>Mic / Line Switch [Ch. 1]</b> .....	<b>9</b>
<b>1/8" Input Jack [Ch. 2]</b> .....	<b>10</b>
<b>Gain Knobs [Ch. 1 and 2]</b> .....	<b>10</b>
<b>Mix Out Jack</b> .....	<b>10</b>
<b>Main Volume Knob</b> .....	<b>11</b>
<b>Voicing Modes</b> .....	<b>11</b>
<b>Outdoor Mode</b> .....	<b>11</b>
<b>Music Ducking</b> .....	<b>12</b>
<b>Feedback Eliminator</b> .....	<b>12</b>
<b>Front LED</b> .....	<b>13</b>
<b>Rackmount Features</b> .....	<b>13</b>
<b>This, That, and The Other Thing Knobs &amp; LEDs</b> .....	<b>13</b>
<b>Genre Knob</b> .....	<b>14</b>
<b>Power &amp; Responsibility Switch</b> .....	<b>14</b>
<b>Woofer and High-Frequency Driver Pan Knobs</b> .....	<b>15</b>
<b>Dry Ice Output Knob and LEDs</b> .....	<b>15</b>
<b>Pyrotechnics Output Knob and LEDs</b> .....	<b>16</b>
<b>Front LED Laser Show Switch</b> .....	<b>17</b>
<b>Bluetooth / Pair</b> .....	<b>17</b>
<b>Speaker Link</b> .....	<b>18</b>
<b>SIG/OL LED</b> .....	<b>18</b>
<b>Factory Reset</b> .....	<b>19</b>
<b>Final Thoughts</b> .....	<b>19</b>

**Chapter 3 : Protection Circuitry ..... 20**

---

**Introduction..... 20**  
**Limiting ..... 20**  
**Overexcursion Protection..... 20**  
**Thermal Protection ..... 20**  
**AC Power ..... 21**  
**Care and Maintenance..... 21**

**Chapter 4 : Placement ..... 22**

---

**Introduction..... 22**  
**Room Acoustics ..... 23**

**Chapter 5 : Rigging..... 24**

---

**Introduction..... 24**  
**Rigging Design Practices..... 24**  
**Rigging Hardware and Accessories ..... 25**  
**Rigging Notes..... 25**  
**THUMPV4 Fly Points ..... 25**

**Hookup Diagrams ..... 26**

---

**Singer-Songwriter Setup..... 26**  
**Small Club System ..... 27**  
**Large Club System ..... 28**  
**DJ System ..... 29**  
**Daisy-Chaining Multiple THUMPV4 Loudspeakers..... 30**

**Appendix A : Service Information..... 31**

---

**Troubleshooting..... 31**  
**No Power ..... 31**  
**No Sound ..... 31**  
**Poor Sound ..... 31**  
**Noise / Hum ..... 32**  
**Bluetooth / Linking Issues ..... 32**  
**Other Issues ..... 32**  
**Repair ..... 32**

**Appendix B : Technical Information** ..... **33**

---

**THUMP12V4 and THUMP15V4 Specifications**..... **33**  
**THUMP12V4 and THUMP15V4 Dimensions**..... **36**  
**THUMP12V4 and THUMP15V4 Block Diagram** ..... **37**

**Warranty Statement** ..... **38**

---

**That's All, Folks!**..... **39**

---

## Chapter 1 : Welcome

---

### Introduction

Hello everyone! This is the THUMP12V4 and THUMP15V4 Owner's Manual. This document contains detailed information about the THUMPV4 loudspeaker series ... we hope you like it!

Whether you're a musician taking the stage or a DJ packing the dance floor, make an impact with the THUMP12V4 and/or THUMP15V4 professional loudspeakers featuring SoundCheck DSP™.

Sound check is as easy as pressing a button, with selectable voicing modes that transforms THUMPV4 into an ideal PA speaker, DJ speaker, stage monitor, or flat speaker with pure sound.

Music Ducking, Feedback Eliminator, and Outdoor Mode are life savers that keep high-pressure professional gigs running smoothly.

Connect your mic and other sources to the built-in mixer. Pair your phone via Bluetooth® for wireless streaming and linking. Control every setting wirelessly from the app.

So there you have it. Again, we hope you like it. If you have any questions or comments about this Owner's Manual (or other Mackie documentation), please don't hesitate to contact us:

- [www.mackie.com/support-contact](http://www.mackie.com/support-contact)

### Features

- Loudest volume with 129 dB maximum SPL [THUMP12V4]
- Loudest volume with 130 dB maximum SPL [THUMP15V4]
- Lowest bass with 39 Hz low frequency response [THUMP12V4]
- Lowest bass with 34 Hz low frequency response [THUMP15V4]
- Clearest sound with SoundCheck DSP™
- 1400W class-D amp, 1" compression driver, 12" woofer [THUMP12V4]
- 1400W class-D amp, 1" compression driver, 15" woofer [THUMP15V4]
- Selectable voicing modes: Flat, DJ, Live, and Wedge
- Instant setup features: Outdoor Mode, Music Ducking, and Feedback Eliminator
- Bluetooth® streaming, linking, and Thump Connect 2 app
- Built-in mixer with inputs for mic and line-level sources
- Premium metal handles and rugged frame
- M10 fly points for suspending and permanent installation

### Things to Remember

- Never listen to loud music for prolonged periods.  
Please see the Safety Instructions on page 2 for information on hearing protection.
- Save the shipping boxes and packing materials! You may need them someday. Besides, the cats will love playing in them and jumping out at you unexpectedly. Remember to pretend like you are surprised!
- Save your sales receipt in a safe place.

## About This Guide

This guide is designed to be accessible, with subsections as complete as practical to minimize having to electronically leaf back and forth looking for the whole story. The entire manual does not need to be read to figure out how to use a THUMPV4 Series loudspeaker.

As the saying goes, “a picture tells a 1000 words”. With that thought in mind, we added quite a few illustrations, screenshots, and other images throughout to accompany the text.



This icon marks information that is critically important or unique! For your own good, read and remember them.



There's an illustration of a microscope, so, of course, you're going to get more detailed information when you see this little guy. There are explanations of features and practical tips listed here.



It's a good idea to pay attention to text displayed next to a note icon, as this icon draws attention to certain features and functions relating to the usage of a THUMPV4 loudspeaker.

## Getting Started Quickly

The following steps will help you set up the THUMPV4 loudspeaker quickly. If you desire a more thorough walk-through of THUMPV4, there is a wealth of information in the following pages!

1. Read and understand the Important Safety Instructions on page 2.
2. Make all initial connections with the power switches OFF on all equipment. Make sure the master volume, level and gain controls are all the way down.
3. If not using a subwoofer, connect the outputs from the mixing console (or other signal source) to the inputs on the rear panel of the loudspeakers.
4. If using a subwoofer, connect the outputs from the mixing console (or other signal source) to the inputs on the rear panel of the subwoofer, then connect the high pass outputs from the subwoofer to the inputs of the loudspeakers.
5. Push the line cord securely into the subwoofer's/loudspeaker's IEC connectors and plug the other ends into grounded AC outlets. The subwoofer/loudspeaker may accept the appropriate voltage as indicated near the IEC connector.
6. Turn the mixer (or other signal source) on.
7. Turn the subwoofer on.
8. Turn the loudspeakers on.
9. Be sure that the volume of the input is the same as it would be during normal use.
10. Start the signal source and raise the mixer's main L/R fader up to a comfortably loud listening level.

## Chapter 2 : THUMPV4 Loudspeaker Series Rear Panel Features

### Thump Connect 2 App

THUMPV4 loudspeakers are designed to be used in conjunction with the Thump Connect 2 App. With it, all of the hardware features listed here – and more! – may be controlled remotely via Bluetooth connection. The only thing the Thump Connect 2 App can't do is turn the unit on and off.

More information about the Thump Connect 2 App may be found by visiting the Thump Connect 2 App Reference Guide.

### Power Connector

This is a standard 3-prong IEC power connector. Connect the detachable power cord (included in the packaging with the loudspeaker) to the power receptacle, and plug the other end of the power cord into an AC outlet.



**VERY IMPORTANT** Make sure that the voltage of the connected electrical supply is matched to the AC voltage indicated on the rear panel (near the IEC input).



**Warning:** Disconnecting the plug's ground pin is dangerous. Don't do it!



### Power Switch

Press the top side of this rocker switch inwards to turn on the loudspeaker. Press the bottom side of this rocker switch inwards to turn off the loudspeaker.

In order to reduce the possibility of any turn-on or turn-off thumps and other noises generated by any equipment from coming out of the speakers, the devices should be turned on in order from the initial input to the final output. Typically, the mixer (or other signal source) would be turned on first, subwoofers next, and loudspeakers last. As such, the loudspeakers would also be turned off first, followed by the subwoofers, then the mixer (or other signal source). System routing may vary, but the principle remains the same.

### XLR and 1/4" Combo Input Jacks



Input channels 1 and 2 may accept a balanced mic signal using an XLR connector.

They are wired as follows, according to standards specified by the AES (Audio Engineering Society).

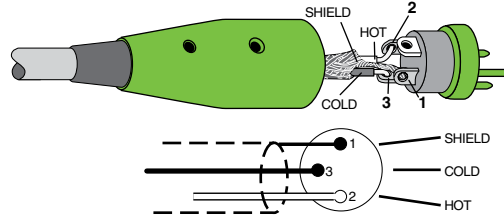

#### **XLR Balanced Wiring:**

- Pin 1 = Shield (ground)
- Pin 2 = Positive (+ or hot)
- Pin 3 = Negative (- or cold)



**NEVER** connect the output of an amplifier directly to a THUMPV4's input jack. This could damage the input circuitry and we wouldn't want that now, would we?

In addition to accepting a balanced mic signal using an XLR connector, these input channels may also accept 1/4" line-level signals driven by balanced or unbalanced sources.

To connect balanced lines to these inputs, use a 1/4" Tip-Ring-Sleeve (TRS) plug. "TRS" stands for Tip-Ring-Sleeve, the three connection points available on a stereo 1/4" or balanced phone jack or plug. TRS jacks and plugs are used for balanced signals and are wired as follows:

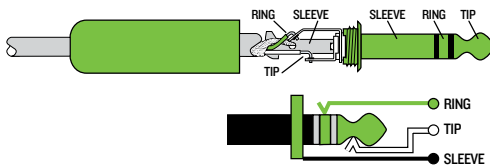

#### **1/4" TRS Balanced Mono Wiring:**

- Tip = Hot (+)
- Ring = Cold (-)
- Sleeve = Shield

To connect unbalanced lines to these inputs, use a 1/4" mono (TS) phone plug, wired as follows:

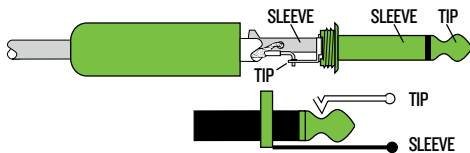

#### **1/4" TS Unbalanced Mono Wiring:**

- Tip = Hot (+)
- Sleeve = Shield



**NEVER** connect the output of an amplifier directly to a THUMPV4's input jack. This could damage the input circuitry and we wouldn't want that now, would we?

### Mic / Line Switch [Ch. 1]



Because an XLR connector may be connected to a mic or an instrument, this momentary switch adjusts the channel's input sensitivity to optimize channel 1 for mic or line-level signals. If a mic is connected, this switch should be engaged and the gain knob set to mic. The switch's LED will illuminate white. If an instrument is connected to channel 1 (via XLR), this switch should be disengaged and the gain knob set to ~12:00. The switch's LED will not illuminate when in line mode.

## 1/8" Input Jack [Ch. 2]

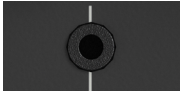

This input channel may accept an 1/8" line-level signal from a phone, tablet, MP3 player, or other signal source.



**NEVER** connect the output of an amplifier directly to a THUMPV4's input jack. This could damage the input circuitry and we wouldn't want that now, would we?



The 1/8" line-level connection may **NOT** be used simultaneously with channel 2's combo jack (XLR or 1/4"). If there is a physical connection to the 1/8" line input and another physical connection to the combo jack, the 1/8" jack takes precedent and the signal to the combo jack will be interrupted. The 1/8" line-level connection and XLR (or 1/4") connection do **NOT** sum together. However, Bluetooth may be used simultaneously with anything connected to the channel 2 input, be it the combo jack or 1/8" input jack.

## Gain Knobs [Ch. 1 and 2]



If you haven't already, please read the "Getting Started Quickly" section on page 7. Setting the gain correctly will ensure that the preamplifier's gain is not too high, where distortion could occur, and not too low, where the quieter, exquisitely-delicate passages might be lost in background noise.

The gain knobs allow signals from the outside world to be adjusted to run through each channel at optimal internal operating levels.

If connecting mixer outputs to THUMPV4 inputs, set the gain knobs to ~12:00 ["U", aka "LINE"] for optimal sound and performance.



Keep in mind that these "MIC" markings and "LINE" suggestions are for reference only and may need to be raised or lower.

## Mix Out Jack

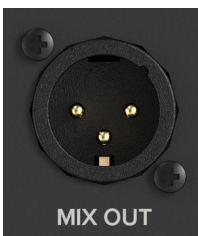

This is a male XLR-type connector that produces a line-level summed-mono mix of all inputs (including Bluetooth). Use it to daisy-chain several THUMPV4 loudspeakers together off the same signal source(s) or add a subwoofer.

This output level is **NOT** affected by the main volume level and is post-channel level, but pre-DSP and pre-main level. It is a pure analog path.

It is wired as follows, according to standards specified by the AES (Audio Engineering Society):

### Balanced XLR Output Connector:

- Pin 1 – Shield (ground)
- Pin 2 – Positive (+ or hot)
- Pin 3 – Negative (– or cold)

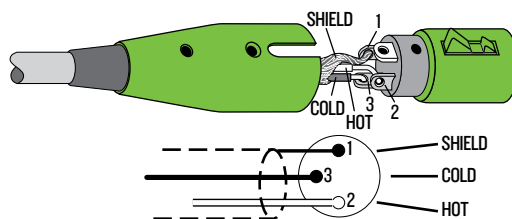

See page 30 to learn more about daisy-chaining THUMPV4 loudspeakers.

## Main Volume Knob

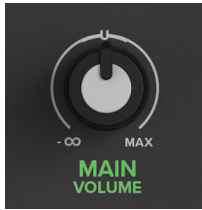

The volume knob adjusts the overall signal level at the input to the built-in power amplifiers. It ranges from Off ( $-\infty$ ) to MAX (maximum gain).

- THUMPV4 loudspeakers are designed to operate with a +22 dBu signal when all knobs are at the center (12:00, “U”) position. Turning the knob past 12:00 allows up to 20 dB of additional gain.

## Voicing Modes

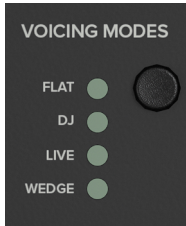

The voicing mode allows you to change the THUMPV4’s voicing to tailor it to best suit your particular application. Press the voicing mode button repeatedly until the LED of the voicing mode you desire is illuminated.

The four voicing modes are as follows:

- **FLAT Voicing Mode** – No question about this speaker mode; it’s flat! Flat mode keeps THUMPV4 transparent, projecting the sound in its purest form. This plug-and-play mode is perfect for singer-songwriters and listening to mastered music. It is optimized to maintain tonal balance at peak output volume.

- **DJ Voicing Mode** – This mode is full range, but focuses on increased bass and brilliant high frequencies. This is the place to start for most DJ / music playback applications.

- **LIVE Voicing Mode** – Mackie take their reputation into a new generation with THUMPV4. It delivers enhanced sound quality, more volume, and modern voicing that makes vocals pop with midrange clarity. Used in live mode, THUMPV4 delivers flawless sound for vocal performances, speeches, and even karaoke. Additionally, this mode works well for singer-songwriters, as it features an upper bass parametric scoop to reduce unwanted low frequency color and adds boost to upper mid-range and high frequencies.

- **WEDGE Voicing Mode** – Wedge mode was tailored to reduce excess low frequency output when coupled with the ground, while also reducing mid-range bite for the artist(s). Putting your foot up on the monitor won’t improve your sound, but wedge mode will.



This mode should only be engaged when the speaker is in its monitor/wedge orientation on a stage or floor... if not, the low-end will sound very lean.

- **À La Mode** – This mode features any of the aforementioned voicing modes, but with a scoop of ice cream.

## Outdoor Mode



Regarding outdoor mode... in a sentence, choose whether you are using the loudspeaker inside or outside.

The speaker’s voicing is altered to the environment. That’s all you need to know, but we’re going to give you more!

When speakers are outside, a combination of low and high frequencies don’t build up the way they do inside. THUMPV4 loudspeakers correct for that by boosting the frequency ranges that become deficient so the speaker sounds the same outside as when it’s inside. You make the selection, we’ll do the rest!

The outdoor mode LED will illuminate green when engaged (outdoors).



When two THUMPV4 loudspeakers are wirelessly linked in stereo mode, the outdoor mode may be engaged on either the primary or secondary THUMPV4. In turn, the outdoor mode will automatically “carry over” to the other THUMPV4 loudspeaker. The outdoor mode cannot be enabled/disabled individually when in stereo mode.

On the other hand, if the THUMPV4 loudspeakers are wirelessly linked in zone mode, the outdoor mode may be enabled/disabled individually. This allows you the opportunity to enable the outdoor mode on one loudspeaker in one zone, while leaving it disabled on another loudspeaker located in another zone.

## Music Ducking

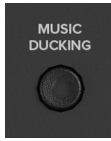

Have you been to an event where music was playing, but when someone spoke into the mic, the music volume decreased greatly (but was still there)? That's called "music ducking"!

When music ducking is engaged, the channel 2 level will decrease when a mic signal is present on channel 1. Additionally, the LED will illuminate green. As if by magic, once the speaking is completed, the music will return back to its previous level. True wizards, those engineers... and none of them have long grey beards, robes, and pointy hats.



The audio nerds out there might like to know that the channel 2 level decreases by 15 dB when a mic signal is present in channel 1 (and when auto-ducking is engaged, of course).



When two THUMPV4 loudspeakers are wirelessly linked in stereo mode, the music ducking may be engaged on either the primary or secondary THUMPV4. In turn, the ducking will automatically "carry over" to the other THUMPV4 loudspeaker. Music ducking cannot be enabled/disabled individually when in stereo mode.

On the other hand, if the THUMPV4 loudspeakers are wirelessly linked in zone mode, music ducking may be enabled/disabled individually. This allows you the opportunity to enable music ducking on one loudspeaker in one zone, while leaving it disabled on another loudspeaker located in another zone.

## Feedback Eliminator

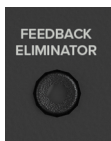

The multi-band feedback eliminator hunts down offending feedback frequencies and applies up to six notch filters automatically to destroy feedback and maximize gain prior to feedback. This is a great tool for when an engineer is not present.

- **Off [Default]** – The feedback eliminator is not engaged. If filters have been applied, this setting will retain its current filter settings if there are any, but they will not be engaged until it is turned back on.
- **On** – When the automatic feedback eliminator is turned on, scanning occurs continuously. The six filters will engage sequentially when feedback is present until all are used and then it will be locked. If feedback is identified on an existing filter, the notch will deepen in three steps to further destroy the offending feedback frequency. Pretty cool, huh? The LED will illuminate green when engaged.

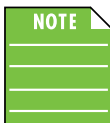

The feedback eliminator **ONLY** affects channel 1 (mic and line mode).



When two THUMPV4 loudspeakers are wirelessly linked in stereo mode, the feedback eliminator may be engaged on either the primary or secondary THUMPV4. In turn, the feedback eliminator will automatically "carry over" to the other THUMPV4 loudspeaker. The feedback eliminator cannot be enabled/disabled individually when in stereo mode.

On the other hand, if the THUMPV4 loudspeakers are wirelessly linked in zone mode, the feedback eliminator may be enabled/disabled individually. This allows you the opportunity to enable the feedback eliminator on one loudspeaker in one zone, while leaving it disabled on another loudspeaker located in another zone.

## Front LED



There is a horizontal LED located near the bottom-front of each THUMPV4. This LED illuminates green in all its glory when the front LED switch is engaged. Disengage the switch if you do not want the front panel LED to illuminate. We like to call this ‘stealth’ mode.



When two THUMPV4 loudspeakers are wirelessly linked in stereo mode, the front LED may be engaged on either the primary or secondary THUMPV4. In turn, the front LED will automatically “carry over” to the other THUMPV4 loudspeaker. The front LED cannot be enabled/disabled individually when in stereo mode.

On the other hand, if the THUMPV4 loudspeakers are wirelessly linked in zone mode, the front LED may be enabled/disabled individually. This allows you the opportunity to enable the front LED on one loudspeaker in one zone, while leaving it disabled on another loudspeaker located in another zone.

## Rackmount Features

As seen to the right, a removable rackmount system is located betwixt the model number and power switch.



Did we say, “removable”? Sure did! Yes, this rackmount system – and all of its features – may be used with other Mackie products! The I/O jacks are located on the backside of the rackmount and will be visible when removed from THUMPV4.

We will go through each feature from left to right. Continue on for additional information!



## This, That, and The Other Thing Knobs & LEDs



The first three knobs on the top row control the overall output level of This, That, and

The Other Thing, respectively. Each control ranges from Off ( $-\infty$ ) to MAX (maximum gain), allowing precise adjustment over how boldly each feature steps into the spotlight.

Signal level is displayed on a single vertical column of seven LEDs — a tiny, judgmental light tower.

For best results, aim to keep the peaks happily bouncing in the green and occasionally flirting with yellow. Yellow means you’re living a little. That’s good.

If the top LED goes solid red, however, congratulations: you’ve entered the “bold choices were made” zone. At this point, This, That, or The Other Thing may stop sounding powerful and start sounding... memorable. And not in the way you intended.

Should red become more than a brief cameo appearance, gently turn the offending knob counterclockwise until the light tower relaxes. Keep things balanced, keep things punchy, and let all three elements shine without fighting for the same square inch of sonic real estate.

### Genre Knob



The final knob on the top row is the all-powerful Genre Knob.

Any music played through the THUMPV4 loudspeaker — live, streamed, reluctantly requested — may be “transformed.” And yes, we mean transformed.

Here’s how it works: Let’s say you’re streaming an aggressively cheerful Top 40 hit. Turn the Genre Knob to “Metal” and suddenly it arrives wearing black eyeliner and has trust issues. Swing it over to “Jazz” and now it owns a vinyl collection and refuses to rush the bridge. The song itself doesn’t stop — it simply discovers new life choices.

Spin the knob quickly and you’ll hear the sound glide through genres like you’re scanning an old AM/FM radio dial in a moving car. It’s nostalgic. It’s chaotic. It’s oddly satisfying.

And here’s where things get interesting: you’re not limited to the labels. Set the knob between two genres to create a hybrid. Reggae-country? Disturbingly plausible. EDM-folk? Somehow still four-on-the-floor. Opera-grunge? We advise supervision.

Use responsibly. Or don’t. That’s what the knob is for.

### Power & Responsibility Switch

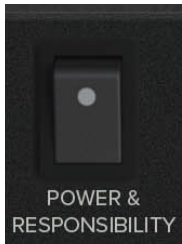

The THUMPV4 Series Power & Responsibility Switch determines whether the rackmount’s “extra” features are actively shaping your sonic destiny... or politely sitting in the corner.

Press the top of the rocker switch to engage the magic. Press the bottom to return to a simpler, less complicated life. The default position is OFF — because responsibility should always be a conscious choice.

The LED illuminates to confirm that the features are alive and ready to influence the mix. If the LED is illuminated, the system is thinking. Possibly judging. Definitely participating. If the LED is off, everything behaves in a calm, predictable, extremely sensible manner.



Choose wisely. After all, with great power comes great responsibility — and slightly better low-end definition.

Now let’s move onto the bottom row of the removable rackmount system, again left to right.



### Woofer and High-Frequency Driver Pan Knobs



Yes. You can pan the woofer. And the high-frequency driver.

No, we're not going to explain why. We're just going to tell you how.

Envision an invisible vertical line running straight down the middle of the THUMPV4 loudspeaker — like a perfectly sliced pizza, separating one half from the other.

With both knobs set to their center detent (12:00 noon, straight up, feeling balanced and emotionally secure), the signal is split 50/50 across both sides of the woofer and high-frequency driver. Peace and harmony. Unity. Symmetry.

Turn the knob left or right, and things start leaning. The signal shifts accordingly, favoring one side of the driver like it just chose a favorite child.

Crank it fully to one side and congratulations — you've committed. All signal goes to that side. The other half? Silent. Reflecting. Possibly reconsidering its life choices.

Is this practical? Not particularly. Is it adjustable? Absolutely. Pan responsibly.

### Dry Ice Output Knob and LEDs



The final two rotary controls on the lower row manage the levels of atmospheric dominance and mild (up to intense) theatrical recklessness:

- Fog Density Threshold (aka Dry Ice)
- Combustive Spectacle Intensity (aka Flame Array, aka Pyrotechnics)

First up, the Fog Density Threshold (aka Dry Ice). Rotate this knob clockwise for “subtle ambiance.” Continue turning for “weather event.”



**Fog Advisory:** Excessive Dry Ice deployment may result in CVO (Complete Visual Obscuration™) of the performance area. In extreme cases, performers, instruments, and, occasionally, entire rhythm sections may appear to dissolve into a mysterious cloud realm. This is normal. The stage has not actually vanished. Probably.



By engaging the Fog Density Threshold (aka Dry Ice) dial beyond 75% (3:00 o'clock), it is acknowledged that:

- The stage may cease to exist visually.
- Guitar solos may become mythological rather than observable events.
- The phrase “more fog” will inevitably be requested ad nauseam.

Furthermore, Mackie is not responsible for:

- Disoriented band members
- Disappointed audience members
- Band, audience, and/or staff members attempting to locate the stage by sound alone

### Metering System

The Fog Density Threshold (Dry Ice) system status is displayed via a single vertical column of seven LEDs.

With a full supply of dry ice, all seven LEDs illuminate in triumphant solidarity. As the performance progresses – and the fog heroically sacrifices itself for dramatic effect – the LEDs slowly (but surely) descend one by one.

When only the bottom one or two LEDs remain illuminated, the loudspeaker is politely suggesting that you are headed towards “breath in the bitter cold” level of output.



At this point, contact the Mackie Parts Department to replenish the dry ice reserves. Please do not attempt to substitute ice cubes, ice cream, iced coffee/tea, icebergs, shaved ice, Italian ice, ICEEs<sup>®</sup>, ice packs, or just about anything else with the word “ice” in it... except dry ice, of course. None are compatible. Failure to do so could land you on thin ice, or worse, transport you back to the Ice Age.

### Pyrotechnics Output Knob and LEDs



The Pyrotechnics Knob – aka Combustive Spectacle Intensity and/or Flame Array – regulates everything from a BIC™ lighter-like flicker to what legal describes as – and I quote – “confidently enthusiastic.”

As the knob is rotated, the settings also change from...

- OFF – 9:00 o'clock – Warm Glow – Suggests passion.
- 9:00 – 12:00 o'clock – Assertive Spark – Suggests commitment.
- 12:00 – 3:00 o'clock – Arena Mode – Suggests poor impulse control.
- 3:00 – MAX – Solar Commentary – Briefly challenges the dominance of the sun.



For best results, increase gradually. Sudden maximum output may result in:

- Eyebrow recalibration
- Instant respect from the smoke detector
- Unexpected interest from the fire marshal
- New conversations with insurance
- A brief but memorable entry in the incident log

If the air begins to shimmer and the front row instinctively leans back, you have achieved optimal spectacle. The goal is spectacle – not folklore.

### Metering System

With a full supply of approved combustive materials, all seven LEDs illuminate in triumphant solidarity – a vertical monument to questionable decision-making.

As the performance progresses – and the flames fearlessly convert fuel into spectacle – the LEDs slowly (but surely) descend one by one.

When only the bottom one or two LEDs remain illuminated, the loudspeaker is politely suggesting that you are approaching birthday candle level of output.

At this point, contact the Mackie Parts Department to replenish your pyrotechnic reserves. Please do not attempt to substitute:

- Intimidation (even if sustained)
- Manifesting
- “Let’s just see what happens”

None are combustibile and we have already seen what happens. Compliance thanks you for your restraint.

### Front LED Laser Show Switch

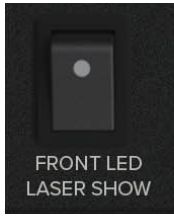

Who doesn't love a good laser light show?

Trick question: no one. Every self-respecting musician—or anyone who enjoys slightly unnecessary spectacle—loves a laser light show!

Engage the Front LED Laser Show by pressing the top side of the rocker switch inwards. Press the bottom side of the rocker switch inwards to turn it off and return to a more “civilized” listening experience. The LED will glow to confirm that the Laser Show is live... but honestly, the lasers themselves are the most reliable source of confirmation—they don't lie, and they work very hard for you.

Default position: OFF, because we wouldn't want to blind anyone accidentally... nor do we want to blind anyone on purpose.

Use responsibly... or not. Either way, it's going to look awesome.

### Bluetooth / Pair

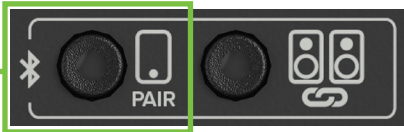

While not a “physical” connection, stereo channel 3/4 is considered the Bluetooth channel and its volume is raised and lowered via the device.

This is how to connect your device to the THUMPV4 loudspeaker via Bluetooth! Read on...

Upon powering up the THUMPV4, the Bluetooth function is either:

- (1) In sleep mode. See 'Pairing and connecting for the first time' (below) or...
- (2) ...Paired and connected. See 'Previously paired and connected devices' (also below).

#### **Pairing and connecting for the first time:**

To enter pairing mode, press and hold the pair switch down for at least three seconds. The LED will illuminate and slow flash blue for approximately 30 seconds while in pairing mode. [The LED will continue to flash until it has successfully paired and connected].

While THUMPV4 is in pairing mode, simultaneously scan for Bluetooth devices on your device. You should see THUMPV4 appear in the list of “available devices”. Select it by tapping it. From there, your Bluetooth device should indicate that it is successfully connected. Additionally, the pair button will stop flashing and remain solid blue. If it does not, start the pairing process again, and make sure that THUMPV4 and your device are both in pairing mode at the same time.

#### **Previously paired and connected devices:**

The Bluetooth connection will disconnect if it's out of range or if THUMPV4 is powered off. Previously paired and connected devices will automatically reconnect (unless turned off via the Thump Connect 2 App) and the pair button will once again illuminate a brilliant blue.

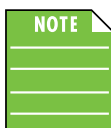

To drop the device from being paired with the THUMPV4, press and hold the 'Bluetooth Pair' button down for at least three seconds.

The Bluetooth connection may disconnect when affected by electrostatic discharge (ESD) or electrical fast transients (EFT). If this occurs, manually reconnect the Bluetooth connection.



If a phone – or two different phones – have been paired via Bluetooth with two THUMPV4 loudspeakers, they will not link. The options are either (1) one phone connected via Bluetooth and THUMPV4 loudspeakers may be linked or (2) two phones connected via Bluetooth to two different THUMPV4 loudspeakers and they may not be linked.

**Speaker Link**

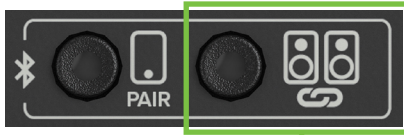

Two THUMPV4 loudspeakers may either be linked together or separate (i.e. not linked). Additionally, there are options when linked, as they support stereo and zone (dual mono) linking. However, those features are only available when connected to the Thump Connect 2 App. It will default to stereo with just the hardware.

**To link:**

In order to link two THUMPV4 loudspeakers, press and hold the 'Link' switch down on the first THUMPV4 loudspeaker until the blue LED begins slow-flashing.

Within (approximately) 30 seconds, a quick press and release of the 'Link' button on the second THUMPV4 allows both units to "see" each other, handshake, and link. The LEDs on both units will stop flashing and remain solid, indicating great success!



THUMPV4 loudspeakers will continue to auto-link on every power-up unless this feature is turned off via the Thump Connect 2 App.

**To unlink:**

In order to unlink two THUMPV4 loudspeakers, press and hold the 'Link' momentary switch / LED down on one of the THUMPV4 loudspeakers until the blue LED turns off. The other THUMPV4 will automatically unlink and the LEDs on both units will turn off.



If a phone – or two different phones – have been paired via Bluetooth with two THUMPV4 loudspeakers, they will not link. The options are either (1) one phone connected via Bluetooth and THUMPV4 loudspeakers may be linked or (2) two phones connected via Bluetooth to two different THUMPV4 loudspeakers and they may be not be linked.

**SIG/OL LED**



This dual-colored LED will illuminate green when the input signal is present, indicating signal.

THUMPV4 loudspeakers have a built-in limiter that helps to prevent the amplifier outputs from clipping or overdriving the transducers. The LED illuminates red when the limiter is activated. It's okay for it to blink red occasionally, but if it blinks frequently or lights continuously, turn down the gain knob until it only blinks occasionally.



Excessive limiting may lead to overheating, which in turn trips the thermal protect circuitry and interrupts the performance. See 'Thermal Protection' on page 20 for more information.

## Factory Reset

Let's also talk factory resets. Since settings may be changed via Thump Connect 2, it may be necessary to reset the THUMPV4 to its factory settings.

There are two kinds of resets:

### **Soft Reset:**

Just a simple power cycle will reset all settings that were previously set via the rear panel and/or app back to their default settings (except for Bluetooth and linked speakers that are stored within THUMPV4).

### **Hard Reset:**

A hard reset resets the entire unit to its factory default, including auto-connect and auto-link. A hard reset may be accomplished by pressing and holding down the 'Feedback Eliminator' and 'Front LED' buttons simultaneously for approximately five seconds on boot up. Release the buttons when all four voicing mode LEDs illuminate simultaneously, as this indicates success.



Please keep in mind that this erases all settings, including any levels, EQs, etc. that may have been set. Be sure to power down any amps and/or powered speakers before resetting THUMPV4.



If you use the factory default key combination, you are also wiping the THUMPV4's memory of previously paired devices. To remedy this, on your phone, tablet, or other Bluetooth device, you will need to 'forget device' in the Bluetooth settings, then re-pair in order to regain communication and functionality.

## Final Thoughts

Just a few final thoughts before we dive into a little more boring "techy"-type stuff. For starters, we would like to remind you once again that THUMPV4 works great on its own, but when paired and connected with a device using the Thump Connect 2 app, your world of possibilities really opens up!

## Chapter 3 : Protection Circuitry

---

### Introduction

THUMPV4 loudspeakers employ a built-in limiter for less distortion at peak levels. A dynamic bass response circuit provides optimal low frequency response regardless of overall output level. Additional protection includes automatic thermal shutdown should the amp overheat. However, with Class-D amp technology, which is highly-efficient, this should never be a problem.



The protection circuits are designed to protect the loudspeakers under reasonable and sensible conditions. Should you choose to ignore the warning signs [e.g. excessive distortion], you can still damage the woofer in the loudspeaker by overdriving it past the point of amplifier clipping. Such damage is beyond the scope of the warranty.

### Limiting

Let's take a peek under the hood at the polymeric compression driver. Compared to other available drivers, these provide a substantially smoother high-frequency response which results in a studio monitor level of accuracy and clarity. Furthermore, these drivers offer an insanely smooth transient response behavior. Yes, we, too, are fans of our own products!

Continuing on, the driver has its own compression circuit which helps protect it from damaging transient peaks. The compressor is designed to be transparent and is not noticeable under normal operating conditions.

### Overexcursion Protection

A subsonic filter circuit just prior to the power amplifier prevents ultra-low frequencies from being amplified. Excessive low-frequency energy can damage the woofer by causing it to "bottom out," also known as overexcursion, which is equivalent to a mechanical form of clipping.

### Thermal Protection

All amplifiers produce heat. THUMPV4 loudspeakers are designed to be efficient both electrically and thermally. In the unlikely event of the amplifier overheating, a built-in thermal switch will activate, muting the signal.

When the amplifier has cooled down to a safe operating temperature, the thermal switch resets itself, and the THUMPV4 loudspeaker resumes normal operation.

If the thermal switch activates, try turning down the level control a notch or two on the mixing console to avoid overheating the amplifier. Be aware that direct sunlight and/or hot stage lights may be the culprit of an amplifier overheating.

### AC Power

Be sure that the THUMPV4 loudspeaker is plugged into an outlet that is able to supply the correct voltage. It will continue to operate at lower voltages, but will not reach full power. Confirm that the electrical service can supply enough amperage for all the components connected to it.

We recommend that a stiff (robust) supply of AC power be used because the amplifiers place high current demands on the AC line. The more power that is available on the line, the louder the speaker will play and the more peak output power will be available for a cleaner, punchier bass. A suspected problem of “poor bass performance” is often caused by a weak AC supply to the amplifiers.



Never remove the ground pin on the power cord – or any other component – of the THUMPV4 loudspeaker. This is very dangerous.

### Care and Maintenance

The THUMPV4 loudspeaker will provide many years of reliable service if you follow these guidelines:

- Avoid exposing it to moisture. If it is set up outdoors, be sure it is under cover if rain is expected.
- Avoid exposure to extreme cold (below freezing temperatures). If you must operate in a cold environment, warm up the voice coils slowly by sending a low-level signal through them for about 15 minutes prior to high-power operation.
- Use a dry cloth to clean the cabinet. Only do this when the power is turned off. Avoid getting moisture into any of the openings of the cabinet, particularly where the drivers are located.

## Chapter 4 : Placement

### Introduction



**WARNING:** Installation should only be done by an experienced technician. Improper installation may result in damage to the equipment, injury, or death. Make sure that the loudspeaker is installed in a stable and secure way in order to avoid any conditions that may be dangerous for persons or structures.

THUMPV4 loudspeakers are designed to sit on the floor or stage as the main PA or as monitors. They may also be pole-mounted via the built-in socket on the bottom of the cabinet. Be sure the pole is capable of supporting the weight of the loudspeaker. The T100 is a great tripod option and the SPM400 is a nice choice when using a subwoofer.

These loudspeakers may also be flown via their integrated fly points as detailed on the following pages. Be sure to read the PA-A3 Eyebolt Installation Instructions, as well.



**NEVER** attempt to suspend a THUMPV4 loudspeaker by its handles.

Check to make sure that the support surface (e.g. floor, etc.) has the necessary mechanical characteristics to support the weight of the loudspeaker(s).

When pole-mounting loudspeakers, be sure that they are stabilized and secured from falling over or being accidentally pushed over. Failure to follow these precautions may result in damage to the equipment, personal injury, or death.

THUMPV4 loudspeakers may be laid out horizontally as monitors for the band at a 40° angle (as seen below). It is intended to be used only when the speaker is in its wedge configuration and works best when on a hard work surface, like a stage.



As seen above, the Running Man logo is rotatable for when the loudspeaker is used as a monitor [International versions of THUMPV4 loudspeakers only]!

## Room Acoustics

THUMPV4 loudspeakers are designed to sound fantastic in nearly every application.

But, room acoustics play a crucial role in the overall performance of a sound system.

However, the wide high-frequency dispersion of the THUMPV4 loudspeakers helps to minimize the problems that typically arise.

Here are some additional placement tips to help overcome some typical room problems that might arise:

- Placing loudspeakers in the corners of a room increases the low frequency output and can cause the sound to be muddy and indistinct.
- Placing loudspeakers against a wall increases the low frequency output, though not as much as corner placement. However, this is a good way to reinforce the low frequencies, if so desired.
- Avoid placing the speakers directly on a hollow stage floor. A hollow stage can resonate at certain frequencies, causing peaks and dips in the frequency response of the room. It is better to place them on a sturdy stand designed to handle the weight of the loudspeaker.
- Position the loudspeakers so the high-frequency drivers are two to four feet above ear level for the audience (making allowances for an audience that may be standing/dancing). High frequencies are highly directional and tend to be absorbed much easier than lower frequencies. By providing direct line-of-sight from the loudspeakers to the audience, you increase the overall brightness and intelligibility of the sound system.
- Highly reverberant rooms, like many gymnasiums and auditoriums, are a nightmare for sound system intelligibility. Multiple reflections off the hard walls, ceiling, and floor play havoc with the sound. Depending on the situation, you may be able to take some steps to minimize the reflections, such as putting carpeting on the floors, closing the drapes, or hanging tapestries or other materials on the walls to absorb some of the sound.

However, in most cases, these remedies are not possible or practical. So what do you do? Making the sound system louder generally doesn't work because the reflections become louder, too. The best approach is to provide as much direct sound coverage to the audience as possible. The farther away you are from the speaker, the more prominent will be the reflected sound.

Use more speakers strategically placed so they are closer to the back of the audience. If the distance between the front and back speakers is more than about 100 feet, you should use an external delay processor to time-align the sound. (Since sound travels about 1 foot per millisecond, it takes about 1/10 of a second to travel 100 feet.)

Keep in mind that the voicing mode is another great way to compensate for some of these issues. See page 11 for more information.

## Chapter 5 : Rigging

---

### Introduction



**WARNING:** Installation should only be done by an experienced technician. Improper installation may result in damage to the equipment, injury, or death. Make sure that the loudspeaker is installed in a stable and secure way in order to avoid any conditions that may be dangerous for persons or structures.



**WARNING:** The cabinet is suitable for rigging via its fly points.  
**NEVER** attempt to suspend a THUMPV4 loudspeaker by its handles.

The fly points are shown at the bottom-left on the following page, while an example of a flown THUMPV4 is displayed to its right.



THUMPV4 loudspeakers may only be flown vertically.

### Rigging Design Practices

Rigging a loudspeaker requires determining:

1. The rigging methods and hardware that meet static, shock, dynamic, and any other load requirements for supporting the loudspeaker from structure.
2. The design factor and required WLL (Working Load Limit) for this support.

We strongly recommend the following rigging practices:

1. Documentation: Thoroughly document the design with detailed drawings and parts lists.
2. Analysis: Have a qualified professional, such as a licensed Professional Engineer, review and approve the design before its implementation.
3. Installation: Have a qualified professional rigger do the installation and inspection.
4. Safety: Use adequate safety precautions and back-up systems.

### Rigging Hardware and Accessories

Rigging THUMPV4 loudspeakers will invariably require hardware not supplied by us. Various types of load-rated hardware are available from a variety of third-party sources. There are a number of such companies specializing in manufacturing hardware for designing and installing rigging systems. Each one of these tasks is a discipline in its own right. Because of the hazardous nature of rigging work and the potential liability, engage companies that specialize in these disciplines to do the work required.

We do offer certain accessory rigging items and some of them may be used with a variety of products. While these accessories are intended to facilitate installation, the wide variety of possible installation conditions and array configurations do not permit us to determine their suitability or load rating for any particular application.

We are not in the business of providing complete rigging systems, either as designers, manufacturers, or installers. It is the responsibility of the installer to provide a properly engineered, load-certified rigging system for supporting the loudspeaker from structure.



THUMPV4 loudspeakers may be individually flown using a PA-A3 Eyebolt Kit, part number 2036960.

### Rigging Notes

The THUMPV4 loudspeaker's integral mounting points are designed to support only the weight of their own loudspeaker with suitable, external hardware. This means that each THUMPV4 loudspeaker must be supported independently of any other THUMPV4 loudspeaker and any other loads. At least the top two rigging points must be used to hang each THUMPV4 loudspeaker. The rear / bottom one helps with an even vertical hang or pullback for a down-tilt angle.

### THUMPV4 Fly Points

MP = Mounting Point

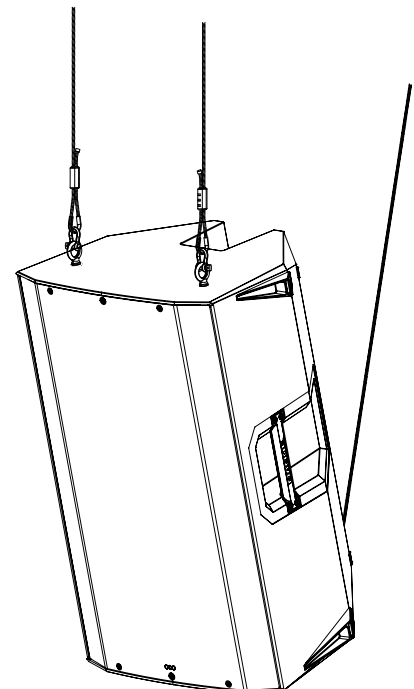
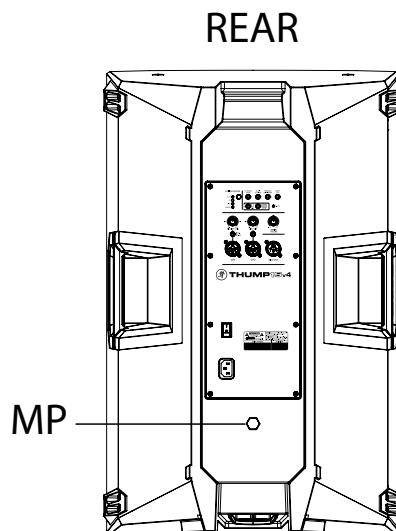
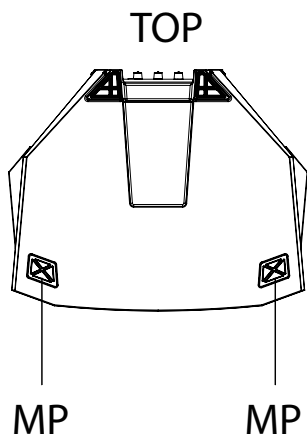

## Hookup Diagrams

### Hookup Diagrams > Singer-Songwriter Setup

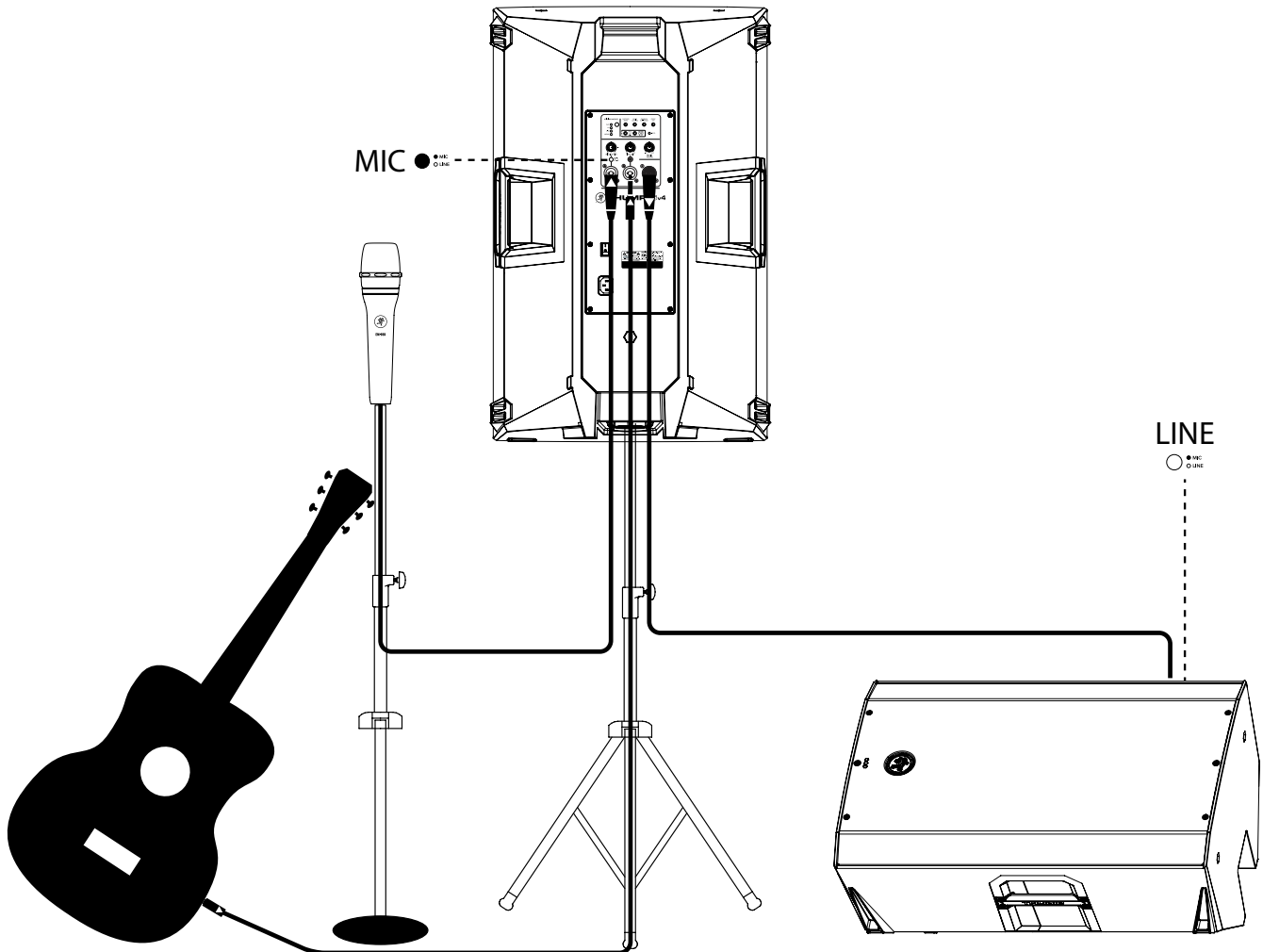

THUMPV4 loudspeakers are the perfect tool for singer-songwriters touring the local coffee shops. Bring your favorite axe and mic, THUMPV4 loudspeakers, cables, and power cords.

In this example, a Mackie EM-89D microphone is connected to the channel 1 input of a THUMPV4 loudspeaker, used as the main PA. The Channel 1 gain knob should be set to Mic (~3:00). The Mic/Line switch should be pressed so that the LED illuminates [Mic], as well. Lastly, set the voicing mode to Flat or Live.

Now grab your axe and plug it directly into the channel 2 input. Or if you use effects, connect the guitar to the effects input and another cable from the effects output to the channel 2 input. Note that the gain knob is set to ~12:00.

An additional THUMPV4 loudspeaker will be used for monitoring purposes. Simply connect a cable from the THUMPV4 PA's MIX OUT jack to the THUMPV4 monitor's channel 1 input. This gain knob should also be set to ~12:00. The Mic/Line switch should be disengaged so that the LED does not illuminate [Line], as well. Since we'll be having a salad for lunch, set the monitor's voicing mode to wedge.

Keep in mind that these "MIC" markings and "MIC/LINE" suggestions are for reference only and may need to be raised or lowered.

Hookup Diagrams > Small Club System

In this example, a ProFX12v3+ mixer is connected directly to two THUMPV4 loudspeakers. It is the perfect setup for a small club or... a fun karaoke house party!

Simply connect the L/R outputs of the ProFX12v3+ mixer to the channel 1 input of each THUMPV4 loudspeaker.

Set the voicing mode of both to live.

The gain knob on both should be set to ~12:00.

The Mic/Line switches should be disengaged [Line, LED not illuminated], as well.

Keep in mind that these "MIC" markings and "MIC/LINE" suggestions are for reference only and may need to be raised or lowered.

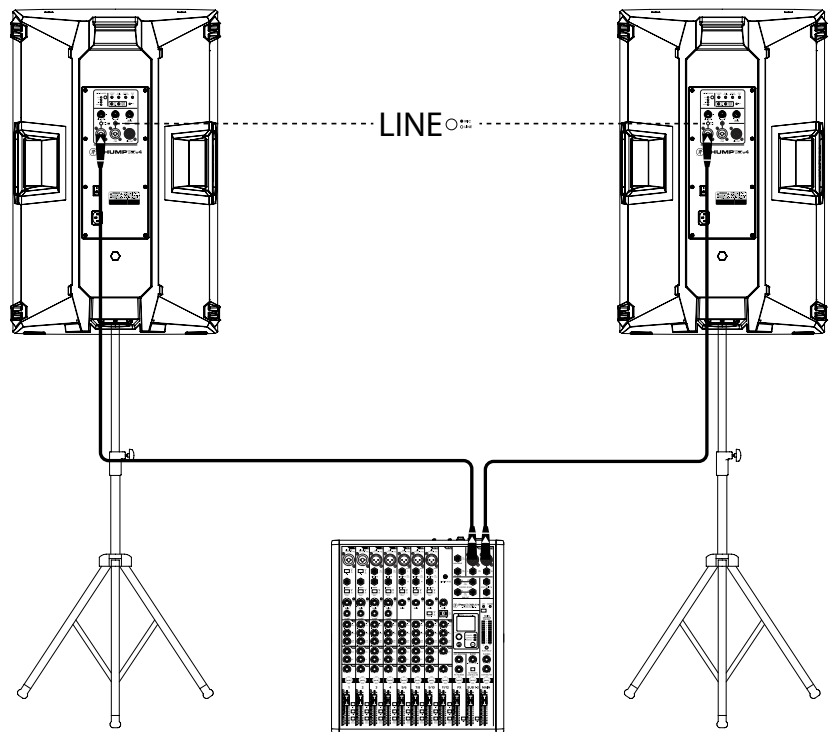

If you desire a little more boom, add a THUMPV4 subwoofer to the mix.

Here, the L/R outputs of a ProFX12v3+ mixer are connected directly to the A and B inputs of a THUMPV4 subwoofer.

Then the High-Pass Outs of the subwoofer are connected to the channel 1 inputs of a pair of THUMPV4 loudspeakers.

Set the high pass mode of the sub to THUMP 12 / THUMP 15 and the voicing mode of both loudspeakers to live.

The gain knob on the subwoofer and both loudspeakers should be set to Unity ("U", 12:00).

The Mic/Line switches should be disengaged [Line, LED not illuminated], as well.

Keep in mind that these "MIC" markings and "MIC/LINE" suggestions are for reference only and may need to be raised or lowered.

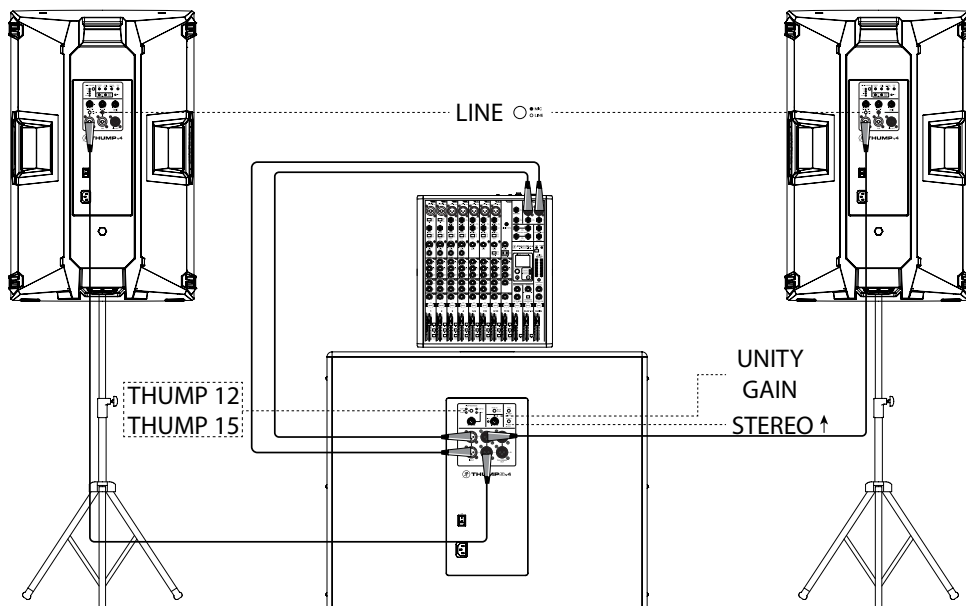

Hookup Diagrams > Large Club System

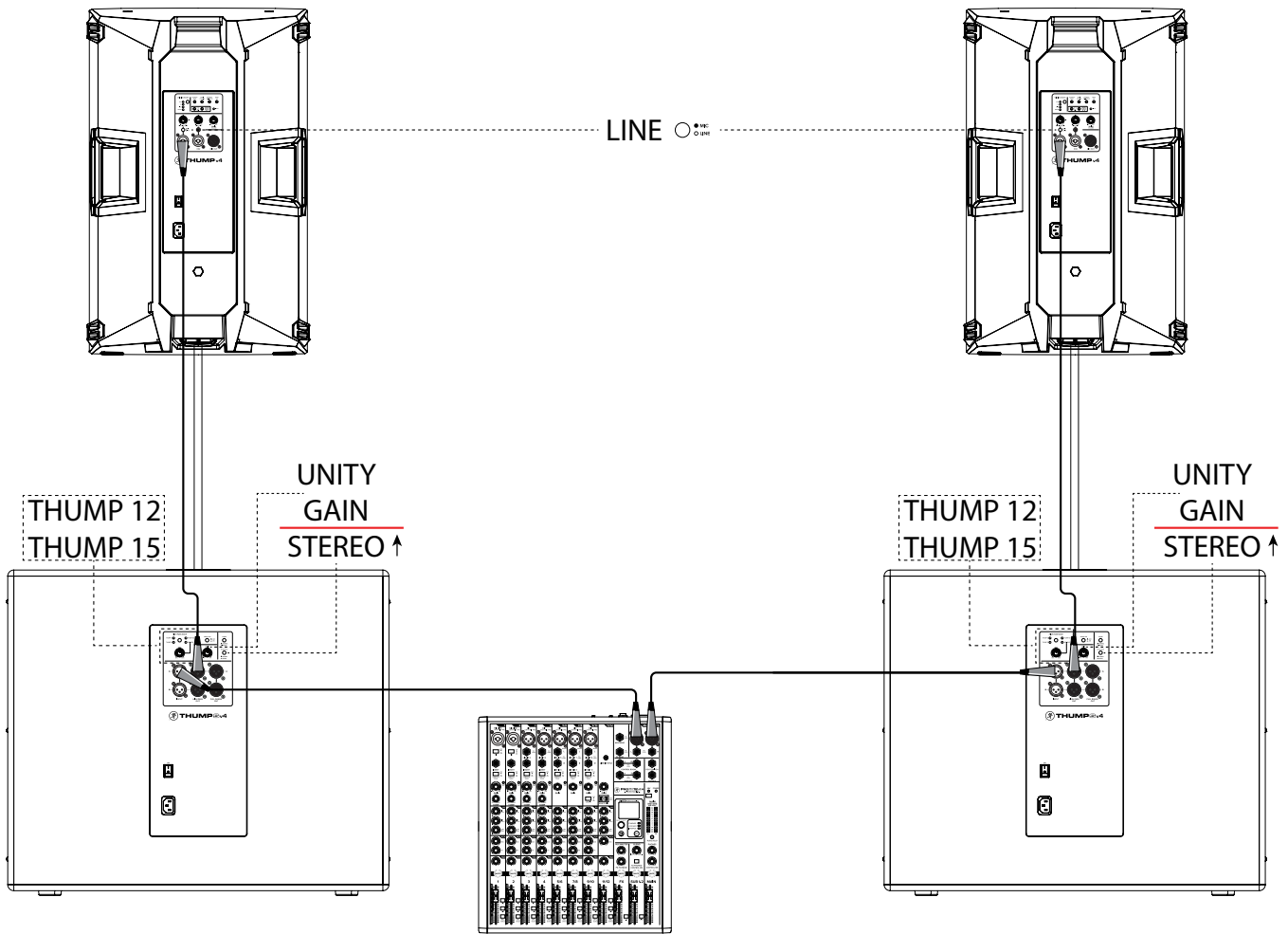

Perhaps the Small Club System didn't have enough beef to it. Alright, ok, we got you. Let's add another THUMPV4 Series subwoofer to the mix. Welcome to the Large Club System! Here, a ProFX12v3+ mixer is connected directly to two THUMPV4 Series subwoofers which, in turn, are connected to a pair of THUMPV4 loudspeakers.

Simply connect the L/R outputs of a mixer directly to the Ch. A input of each THUMPV4 Series subwoofer. Then the Ch. A high-pass output jack of each subwoofer is connected to the channel 1 input of each THUMPV4 loudspeaker.

Here, you will want to set the subwoofer's High Pass Mode to THUMP 12 or THUMP 15, depending on the loudspeaker, of course. THUMP GO and a 80-160 Hz variable knob are the other two High Pass Mode choices. The gain knobs on the subwoofer and both loudspeakers should be set to unity gain (12:00 noon, pointing straight up). Additionally, the Mic/Line switches should be disengaged [Line]. Keep in mind that these "U" (for unity) and "MIC/LINE" suggestions are for reference only and may need to be raised or lowered.



As system size increases, so do power requirements. Refer to "AC Power" on page 21 for additional guidance.

Hookup Diagrams > DJ System

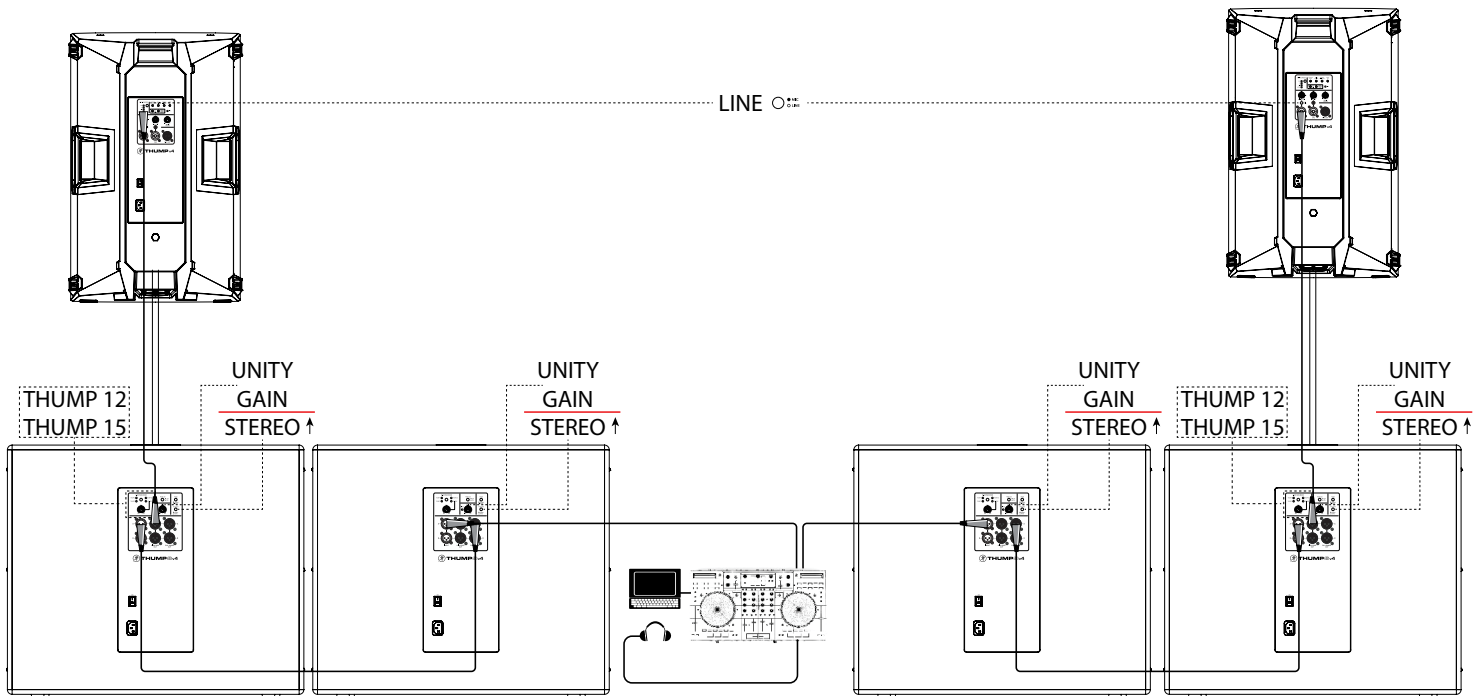

Want even *more* low end? You're in luck! Let's add another pair of THUMPV4 Series subwoofers to the mix. Welcome to the DJ System! Visualize that you're a DJ playing bumpin' tunes in the middle of the night to a crowd that's groovin' and dancin' to your fine selection.

Here, a laptop is connected to a DJ controller. A set of Mackie MC-350 headphones is connected to the phones jack of the DJ controller.

The L/R outputs of the DJ controller are then connected to the Ch. A inputs of two THUMPV4 Series subwoofers. The Ch. A full-range output of the first two THUMPV4 Series subwoofers are then connected to the Ch. A inputs of the next THUMPV4 Series subwoofers. Then the Ch. A high-pass output jacks of the second set of subwoofers is connected to the Ch. 1 input on each THUMPV4 loudspeaker.

The gain knobs on the subwoofer and both loudspeakers should be set to unity gain (12:00 noon, pointing straight up). Additionally, the Mic/Line switches should be disengaged [Line]. Keep in mind that these "U" (for unity) and "MIC/LINE" suggestions are for reference only and may need to be raised or lowered.



As system size increases, so do power requirements. Refer to "AC Power" on page 21 for additional guidance.

Hookup Diagrams > Daisy-Chaining Multiple THUMPV4 Loudspeakers

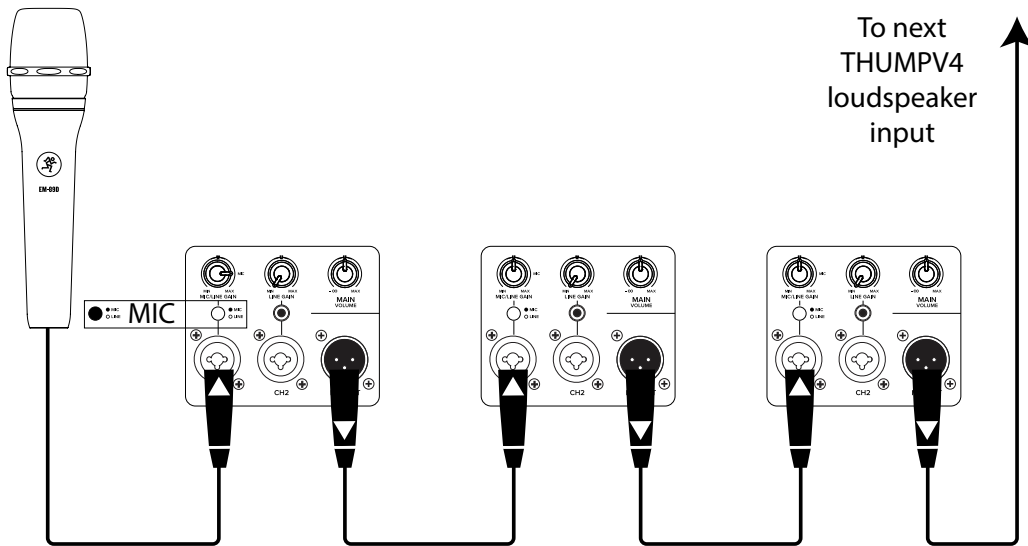
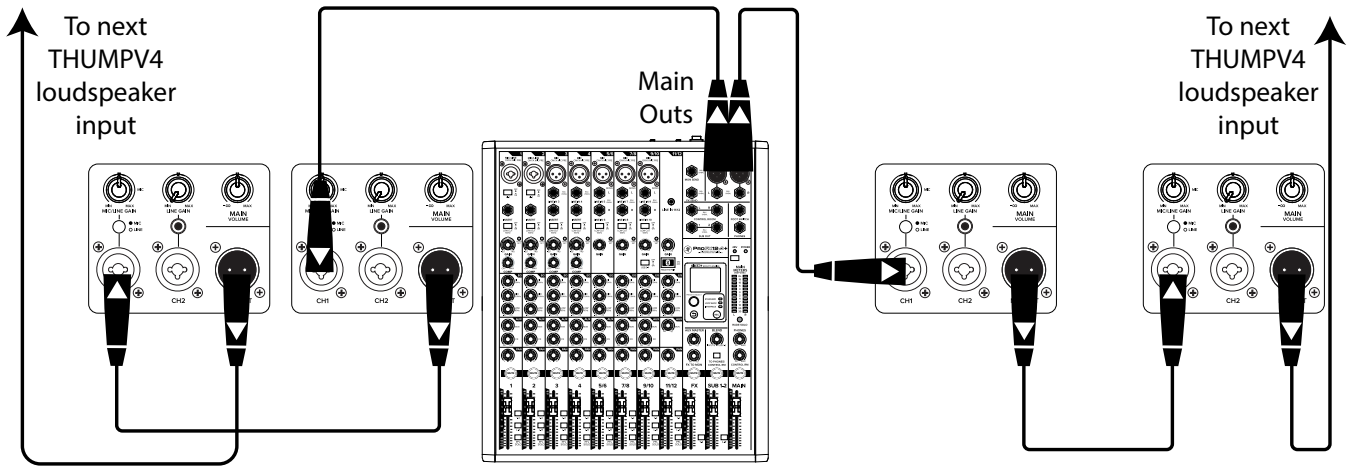

THUMPV4 loudspeakers may be daisy-chained via the “MIX OUT” jack which outputs all inputs. Simply plug the signal source (i.e., mixer output or microphone) into the input jack(s), and patch that loudspeaker’s mix out jack to the next loudspeaker’s input jack, and so on, daisy-chaining multiple THUMPV4 loudspeakers. See above for visual representations of daisy-chaining.

**NOTE:** Make sure to set the gain knob(s) correctly. In the top diagram, all input channels are set to approximately ~12:00 [i.e. “LINE”] and in the bottom diagram, input Ch. 1 of the first THUMPV4 is set to “MIC” (~3:00), but the remaining ones should be set to approximately “12:00”. Notice that the mic-line switch is set to “LINE” in all images above, except for the first loudspeaker in the bottom image since it has a mic connected to it. Keep in mind that these are suggestions only and the gain knobs may need to be raised or lowered.

## Appendix A : Service Information

---

### Troubleshooting

If you think your THUMPV4 Series loudspeaker has a problem, please check out the following troubleshooting tips and do your best to confirm the problem. Visit the Support section of our website ([www.mackie.com](http://www.mackie.com)) where you will find lots of useful information such as FAQs and other documentation. You may find the answer to the problem without having to part with your loudspeaker.

Here are some useful tips that could correct any of the issues outlined below (or possibly any other issue that we haven't yet discovered):

**Getting Started Quickly:** If you are having any sound (or non-sound) issues, try following the level setting procedure as outlined on page 7 to verify that all of the volume controls in the system are properly adjusted.

There are no user serviceable parts. If none of these tips work, please refer to "Repair" on the next page to find out how to proceed.

### No Power

- Our favorite question: Is it plugged in? Make sure the AC outlet is live [check with a tester or lamp].
- Our next favorite question: Is the power switch on? If not, try turning it on.
- Make sure the line cord is securely seated in the line cord socket and plugged all the way into the AC outlet.
- Is a voicing mode LED illuminated? If not, make sure the AC outlet is live. If so, refer to "No Sound" below.
- The internal AC line fuse may be blown. This is not a user serviceable part. If you suspect the AC line fuse is blown, please see the "Repair" section next.

### No Sound

- Is the level knob for the input source turned all the way down? Verify that all the volume controls in the system are properly adjusted. Look at the level meter to ensure that the mixer is receiving a signal.
- Is the signal source working? Make sure the connecting cables are in good repair and securely connected at both ends. Make sure the output level control on the mixing console is turned up sufficiently to drive the inputs of the speaker.
- Make sure the mixer does not have a mute on or a processor loop engaged. If you find something like this, make sure the level is turned down before disengaging the offending switch.
- Has it shut down? Make sure there is at least six inches of free space behind each loudspeaker.

### Poor sound

- Is it loud and distorted? Make sure that you're not overdriving a stage in the signal chain. Verify that all level controls are set properly.
- Is the input connector plugged completely into the jack? Be sure all connections are secure.
- Perhaps giving it some money might help? Then it will be... wealthy sound?!
- Are there phasing issues? The signal source should only be connected to a single input. For example, do not connect the L/R outputs from a mixer to the THUMPV4 channel 1 and 2 inputs. Do not use a Y cable to split a phone's signal, use both outputs of a stereo synth (which sums to mono, anyway), etc. Another contributor to phasing is room reflections. Be sure to read more about room acoustics on page 23.

### Noise / Hum

- Make sure all connections to the loudspeakers are good and sound.
- Make sure none of the signal cables are routed near AC cables, power transformers, or other EMI-inducing devices. EMI-inducing devices can be anything from microwave ovens, touch-controlled lamps, electric blankets, or any other electronics that emit their own electromagnetic field / radio frequency radiation that can cause interference.
- SCR-based devices on the same AC circuit as the THUMPV4 subwoofer may introduce electrical noise. These Silicon Controlled Rectifiers are typically used in light dimmers and other high-power switching applications. Use an AC line filter or plug the subwoofer into a different AC circuit.
- Try disconnecting the cable connected to the input jack. If the noise disappears, it could be a “ground loop,” rather than a problem with the loudspeaker.

Try some of the following troubleshooting ideas:

- Use balanced connections throughout your system for the best noise rejection.
- Whenever possible, plug all the audio equipment's line cords into outlets which share a common ground. The distance between the outlets and the common ground should be as short as possible.

### Bluetooth / Linking Issues

- Sometimes a good 'ol fashioned reset works wonders. There are two types, soft and hard. See page 19 for more info on resetting a THUMPV4 loudspeaker.
- Try linking two THUMPV4 loudspeakers together prior to connecting via Bluetooth.

### Other Issues

- Please email Technical Support if you are having any other issue not listed here:
  - o [mackie.com/support-contact](mailto:support@mackie.com)

### Repair

For warranty service, refer to the warranty information on page 38.

Non-warranty service for Mackie products is available at a factory-authorized service center. To locate the nearest service center, visit [www.mackie.com](http://www.mackie.com), click “Support” and select “Service Center Locator”. Service for Mackie products living outside the United States may be obtained through local dealers or distributors.

## Appendix B : Technical Information

### THUMP12V4 AND THUMP15V4 SPECIFICATIONS

#### Acoustic Performance

Frequency Response (-10 dB) .....	39 Hz - 20 kHz [THUMP12V4] 34 Hz - 20 kHz [THUMP15V4]
Frequency Response (-3 dB) .....	47 Hz - 20 kHz [THUMP12V4] 41 Hz - 20 kHz [THUMP15V4]
Horizontal Coverage (-6 dB) .....	90°
Vertical Coverage (-6 dB) .....	50°
Maximum SPL Peak .....	129 dB [THUMP12V4] 130 dB [THUMP15V4]
Monitor Angle .....	40°

#### Transducers

Low Frequency .....	12 in / 305 mm woofer with ferrite [THUMP12V4] 15 in / 381 mm woofer with ferrite [THUMP15V4]
High Frequency .....	1.0 in / 25 mm high-temperature polymeric compression driver

#### Power Amplifiers

System Power Amplification	
Rated Power .....	1400 watts peak
Low Frequency Power Amplifier	
Rated Power .....	1200 watts peak
Rated THD .....	<1%
Cooling .....	Convection
Design .....	Class D
High Frequency Power Amplifier	
Rated Power .....	200 watts peak
Rated THD .....	<1%
Cooling .....	Convection
Design .....	Class D

**Automobiles**

Exotic / Luxury Vehicles.....	Aston Martin, Ferrari, Lamborghini, Bentley, Bugatti, McLaren
Sedans .....	Lexus, BMW, Acura, Saab, Audi, Honda, Volkswagen, Volvo, Hyundai, Kia
SUVs .....	Jeep, Land Rover, Toyota, Subaru
Convertibles .....	Porsche, Jaguar, Mercedes-Benz, Mazda
Trucks .....	Dodge, GMC, Rivian, Nissan, Ram

**Input / Output**

Input Type .....	2x Female XLR – 1/4" Balanced TRS combo jack, 1/8" TRS, and Bluetooth
Mic/Line Impedance .....	10 kΩ Balanced
1/8" Line Impedance .....	10 kΩ Balanced
Mix Out .....	Male XLR Balanced
Mix Out Impedance .....	150 Ω Balanced

**Electronic Crossover**

Crossover Frequency .....	1.8 kHz
---------------------------	---------

**Bluetooth Information**

Bluetooth Protocol .....	5.0
Bluetooth Function .....	Audio streaming and user interface control

**Line Input Power**

Detachable line cord.....	100–240V~, 50–60 Hz, 300W [THUMP12V4] 100–240V~, 50–60 Hz, 350W [THUMP15V4]
AC Connector.....	3-pin IEC 250 VAC, 10 A male
Power Supply Type.....	Switchmode Universal mains regulated power supply with PFC integrated

**System Processing**

Voicing Mode .....	Four voicing modes Flat, DJ, Live, Wedge
--------------------	---------------------------------------------

**Safety Features**

Transducer Protection ..... Peak and RMS limiting  
 Environmental Protection ..... Power supply and amplifier thermal protection  
 Feedback Eliminator ..... On / Off  
 Display LEDs ..... Voicing Mode, Outdoor Mode,  
 Music Ducking, Feedback Eliminator,  
 Front LED, Bluetooth Status,  
 Link Status, Signal/Overload

**Physical Properties**

**THUMP12V4**

Height ..... 24.4 in // 620 mm  
 Width ..... 14.0 in // 356 mm  
 Depth ..... 14.0 in // 356 mm  
 Weight ..... 27.5 lb // 12.5 kg

**THUMP15V4**

Height ..... 27.4 in // 696 mm  
 Width ..... 17.3 in // 439 mm  
 Depth ..... 14.0 in // 356 mm  
 Weight ..... 32.6 lb // 14.8 kg

**Mounting Methods**

Floor mount, pole mount via the built-in socket on the bottom of the cabinet [Be sure the pole is capable of supporting the weight of the THUMPV4 loudspeaker], or fly via the integrated M10 mounting points (using M10 x 1.5 x 17 mm forged shoulder eyebolts). See pages 22-25 for more information.

**Options**

THUMP12V4 Speaker Bag ..... P/N 2047360-09  
 THUMP12V4 Rolling Speaker Bag ..... P/N 2047360-10  
 THUMP15V4 Speaker Bag ..... P/N 2047360-11  
 THUMP15V4 Rolling Speaker Bag ..... P/N 2047360-12  
 T100 Loudspeaker Tripod Stand ..... P/N 2052464  
 SPM400 M20 Threaded Loudspeaker Pole Mount ..... P/N 2051055  
 PA-A3 Forged Shoulder Eyebolt Kit (3 x M10 x 17 mm) ..... P/N 2036960

**About**

Part Number, Rev and Date ..... SW1503, Rev B, May 2026

**Disclaimer**

LOUD Audio, LLC. is always striving to improve our products by incorporating new and improved materials, components, and manufacturing methods. Therefore, we reserve the right to change these specifications at any time without notice. The "Running Man" is a registered trademark of LOUD Audio, LLC. All other brand names mentioned are trademarks or registered trademarks of their respective holders, and are hereby acknowledged.

Please check our website for any updates to this Owner's Manual: [www.mackie.com](http://www.mackie.com).  
 ©2026 LOUD Audio, LLC. All right All right All rights reserved.

**THUMP12V4 Dimensions**

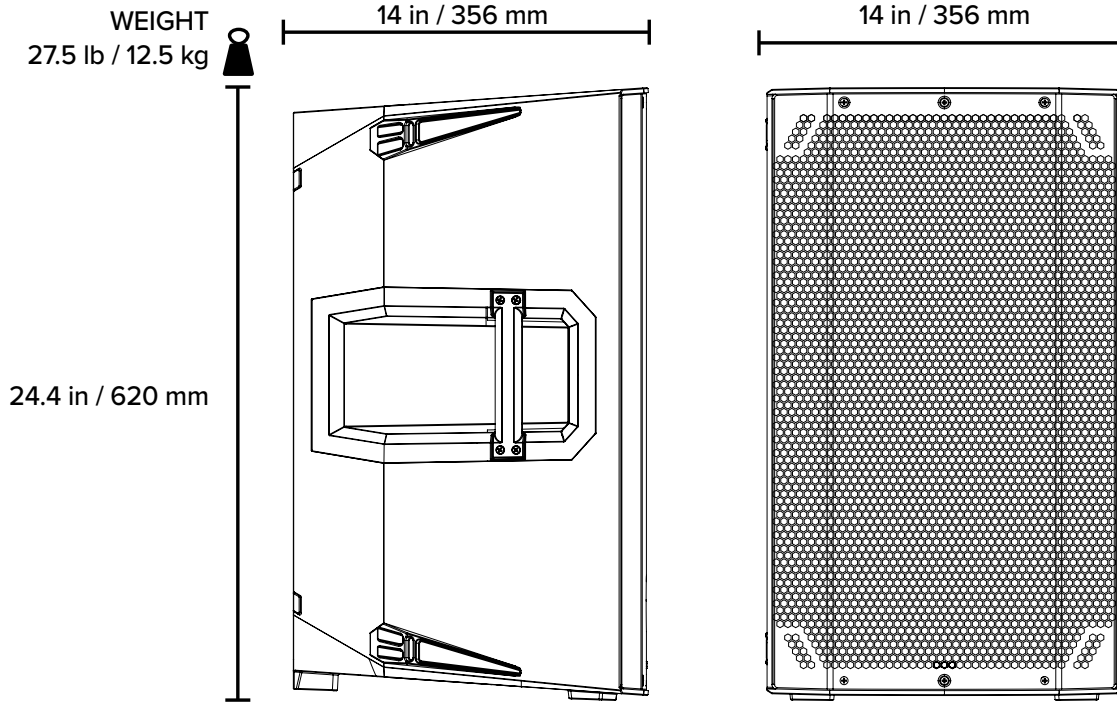

**THUMP15V4 Dimensions**

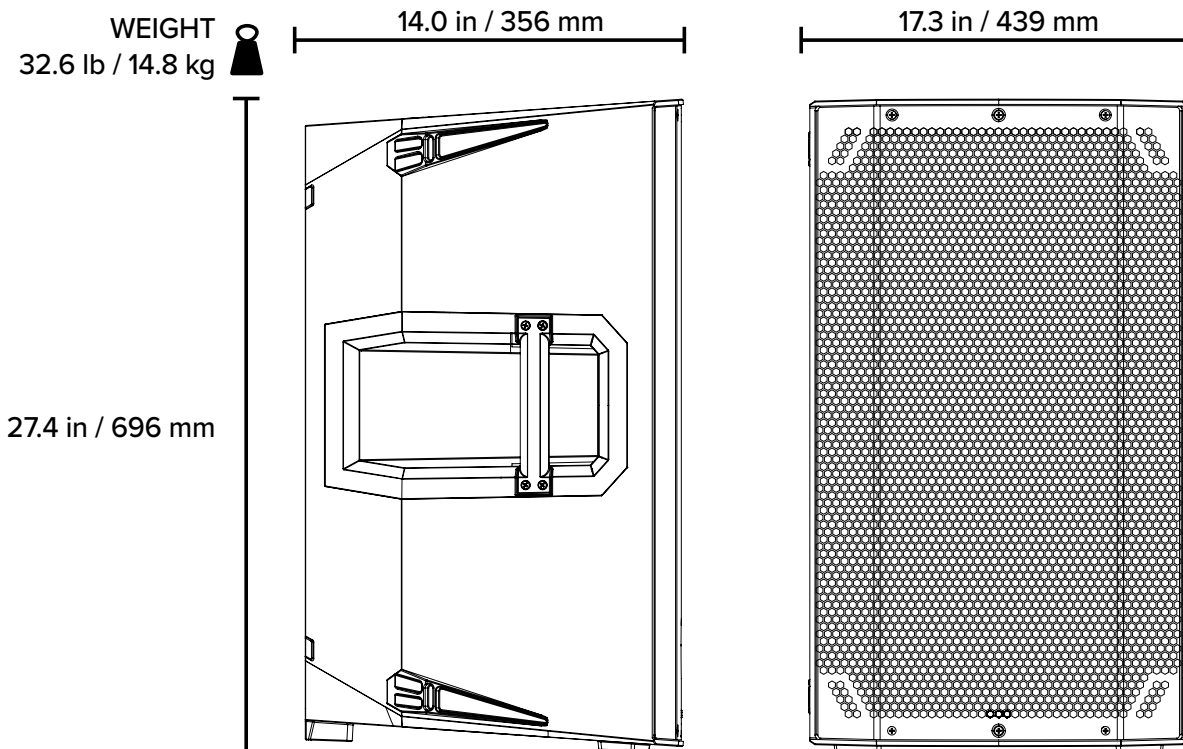

THUMP12V4 and THUMP15V4 Block Diagram

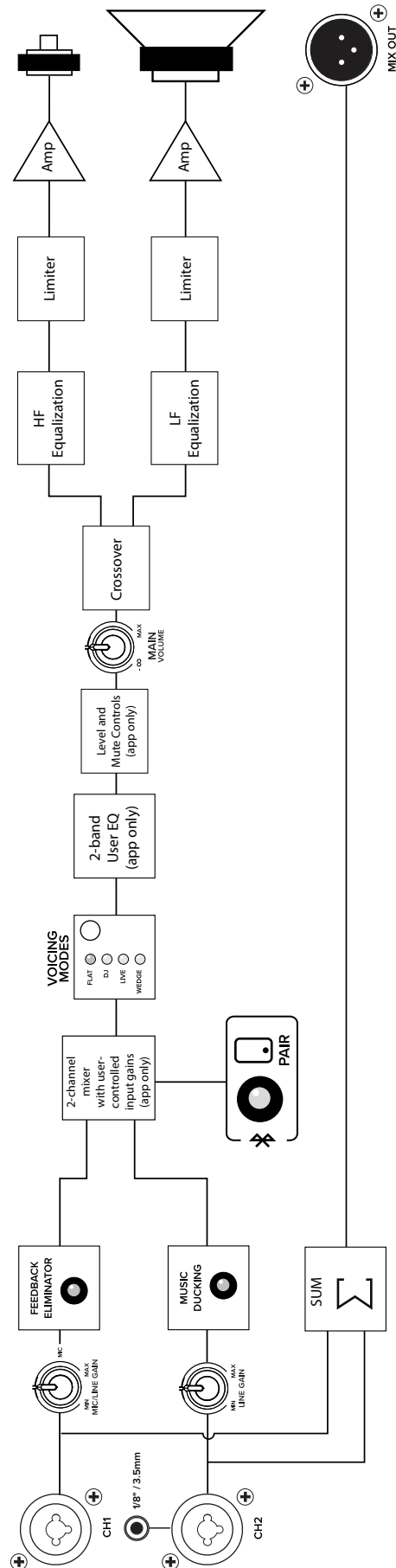

## Warranty Statement

### Please keep your sales receipt in a safe place.

This Limited Product Warranty ("Product Warranty") is provided by LOUD Audio, LLC. ("LOUD") and is applicable to products purchased in the United States or Canada through a LOUD-authorized reseller or dealer. The Product Warranty will not extend to anyone other than the original purchaser of the product (hereinafter, "Customer," "you" or "your").

For products purchased outside the U.S. or Canada, please visit [www.mackie.com/warranty](http://www.mackie.com/warranty) to find contact information for your local distributor, and information on any warranty coverage provided by the distributor in your local market.

LOUD warrants to Customer that the product will be free from defects in materials and workmanship under normal use during the Warranty Period. If the product fails to conform to the warranty then LOUD or its authorized service representative will at its option, either repair or replace any such nonconforming product, provided that Customer gives notice of the noncompliance within the Warranty Period to the Company at: [www.mackie.com/support](http://www.mackie.com/support) or by calling LOUD technical support at 1.800.898.3211 (toll-free in the U.S. and Canada) during normal business hours Pacific Time, excluding weekends or LOUD holidays. Please retain the original dated sales receipt as evidence of the date of purchase. You will need it to obtain any warranty service.

For full terms and conditions, as well as the specific duration of the Warranty for this product, please visit [www.mackie.com/warranty](http://www.mackie.com/warranty).

The Product Warranty, together with your invoice or receipt, and the terms and conditions located at [www.mackie.com/warranty](http://www.mackie.com/warranty) constitutes the entire agreement, and supersedes any and all prior agreements between LOUD and Customer related to the subject matter hereof. No amendment, modification or waiver of any of the provisions of this Product Warranty will be valid unless set forth in a written instrument signed by the party to be bound thereby.

### Need help with the THUMP12V4 and/or THUMP15V4 loudspeaker?

- Visit [www.mackie.com/support](http://www.mackie.com/support) to find: FAQs, manuals, addendums, and other documents.
- Email us at: [www.mackie.com/support-contact](http://www.mackie.com/support-contact)

Please write the serial numbers here for future reference  
(i.e., insurance claims, tech support, return authorization, make dad proud, etc.)

**Purchased at:**

**Date of purchase:**



19820 North Creek Parkway #201  
Bothell, WA 98011 • USA  
[www.mackie.com](http://www.mackie.com)

**MACKIE®**